

MESA/BOOGIE[®]

MARK 5
TWENTY-FIVE[™]

Owner's Manual

Hello from the Tone Farm

Congratulations! The amplifier you have chosen is born of thoroughbred stock that carries worldwide accolades and is still setting trends with top Artists 35 years after its unveiling. The MARK FIVE: 25, like the MARK FIVE it is born from, is really a collection of iconic amplifiers. There are far too many circuits and sounds to think of it as merely an amp... it's a living history of MESA/Boogie! From the groundbreaking MARK I that introduced the world to high-gain with its cascading preamp, to the Mark II, the world's first high gain Dual Mode Channel Switching amplifier (and its later siblings that introduced Simul-Class™ power). From the MARK III that ushered in the era of 3 Channel footswitching. performance, to the MARK IV which gave all that power individual control, the MARK FIVE (and now the MARK FIVE: 25) is the embodiment of the last 45 years of guitar amp evolution.

In this latest 25 Watt incarnation, the sounds and attributes that make MARK Series amps so popular on stage and in the studio are not only shrunk to their smallest possible physical size, but are also further refined and improved. The gorgeous sparkling Cleans and soaring high gain Lead sounds have made the jump successfully across output tube platforms and a new and exciting timbre of the MARK Series voice is created here in the MARK FIVE: 25's EL84 Duet. Brighter, tighter, more shredding in the top end, a bit more forgiving in feel and exceedingly more clip-able, the FIVE: 25 is right on time. Whether introducing the MARK heritage to a new generation of low wattage devotees, or fulfilling the ultra-portable Tone Dreams of steadfast MARK Series fans, the MARK FIVE: 25 has got what it takes to inspire and fuel your passion in the most manageable package ever!

MARK 5

TWENTY-FIVE™

Table of Contents

PRECAUTIONS	
OVERVIEW	1-5
GETTING STARTED	6
HELPFUL HINTS	7-8

FRONT PANEL

THE CHANNELS: MODE BY MODE	9-10
THE MODES IN DEPTH: CHANNEL 1	11-12
THE MODES IN DEPTH: CHANNEL 2	13-16

THE CONTROLS

INPUT, FT SW, GAIN	17-18
TREBLE	18
MID/BOOST: CHANNEL 1	19
MID: CHANNEL 2	19-20
BASS	20
PRESENCE	20-21
MASTER	21-22
5-BAND GRAPHIC	22-23
MULTI-WATT™ POWER	23
POWER	24
STANDBY	24

REAR PANEL

MAIN FUSE	25
AC MAINS SOCKET	25
FX LOOP	25-26
HEADPHONE	26-27
REVERB	27
SPEAKERS	27-28
CabClone™ D.I.	28-30
FACTORY SAMPLE SETTINGS	32-33
USER SETTINGS	34-35
TUBE TROUBLE SHOOTING GUIDE	36-37
SPEAKER HOOKUP GUIDE	38-43
TUBE TASK CHART	44
PARTS SHEET	45

IMPORTANT SAFETY INSTRUCTIONS

Read these instructions.

Keep these instructions.

Heed all warnings.

Follow all instructions.

Do not use this apparatus near water.

Clean only with dry cloth.

Do not block any ventilation openings. Install in accordance with the manufacturer's instructions.

Do not install near any heat sources such as radiators, heat registers, stoves, or other apparatus (including amplifiers) that produce heat.

Do not defeat the safety purpose of the polarized or grounding-type plug. A polarized plug has two blades with one wider than the other. A grounding type plug has two blades and a third grounding prong. The wide blade or the third prong are provided for your safety. If the provided plug does not fit into your outlet, consult an electrician for replacement of the obsolete outlet.

Protect the power cord from being walked on or pinched particularly at plugs, convenience receptacles, and the point where they exit from the apparatus.

Only use attachments/accessories specified by the manufacturer.

Unplug this apparatus during lightning storms or when unused for long periods of time.

Refer all servicing to qualified service personnel. Servicing is required when the apparatus has been damaged in any way, such as power-supply cord or plug is damaged, liquid has been spilled or objects have fallen into the apparatus, the apparatus has been exposed to rain or moisture, does not operate normally, or has been dropped.

To insure proper ventilation always make sure there is at minimum four inches (101.6mm) of space behind the rear of the apparatus. The ventilation should not be impeded by covering the ventilation openings with items, such as newspapers, tablecloths, curtains, etc. Do not impede ventilation by placing objects on top of the apparatus which extend past the rear edge of its cabinet.

No naked flame sources, such as lighted candles, should be placed on the apparatus.

The apparatus shall not be exposed to dripping or splashing and no objects filled with liquids, such as vases, shall be placed on the apparatus.

WARNING: To reduce the risk of fire or electric shock, do not expose this apparatus to rain or moisture.

The AC plug is the mains disconnect. The plug should remain accessible after installation.

WARNING: EU: permission from the Supply Authority is needed before connection.

WARNING: Always make sure proper load is connected before operating the amplifier. Failure to do so could pose a shock hazard and may result in damage to the amplifier.

Do not expose amplifier to direct sunlight or extremely high temperatures.

Always insure the amplifier is properly grounded. Always unplug AC power cord before changing fuse, tubes or removing chassis. Use only same type and rating when replacing fuse.

Avoid direct contact with heated tubes. Keep amplifier away from children.

To avoid damaging your speakers and other playback equipment, turn off the power of all related equipment before making the connections.

Do not use excessive force when handling buttons, switches and controls. Do not use solvents such as benzene or paint thinner to clean the unit.

Always connect to an AC power supply that meets the power supply specifications listed on the rear of the unit. Export models: always insure unit is wired for proper voltage. Make certain grounding conforms with local standards.

YOUR AMPLIFIER IS LOUD! EXPOSURE TO HIGH SOUND VOLUMES MAY CAUSE PERMANENT HEARING DAMAGE!

Your Mesa/Boogie Amplifier is a professional instrument. Please treat it with respect and operate it properly.

READ AND FOLLOW INSTRUCTIONS OF PROPER USAGE.

MARK 5 TWENTY-FIVE™

Operating Instructions

Overview:

NOTE: This section appears on our website. Feel free to skip this section and go straight to “GETTING STARTED” if you have read it there or don’t need a global overview of the amplifier.

It was back to the wellspring of past MARK amps for inspiration on the MARK FIVE: 25, so we once again revisited the most coveted of them all, the MARK II-C+. We compared that vintage icon and the production 6L6 powered MARK FIVE (being our best work to date at paying tribute to II-Cs) and listened to what the current MARK had to offer. After confirming that many of the MARK FIVE Modes absolutely HAD to be in this mini package... and that they TRULY sounded on par with (or even better than) the II-C+, we set out to find a layout that fit 6 incredible Modes into a sub-compact chassis size.

Overwhelmingly, those polled rallied for two—and only two—preamp channels for a tiny MARK amp. With pedals now offering such a personalized, quick-change approach to getting different sounds, we agreed and set to work defining the FIVE: 25’s two Channels. We’ve arrived at a collection that includes the very best of the MARK IIC+, the MARK IV and the MARK FIVE in a package that’s truly unbelievable in size. The result is a new Bench-MARK, every bit a fully pro model and worthy of its ancestor’s storied heritage.

Packing the stylistic width, versatility, aggressiveness and Tone of the MARK FIVE, the MARK FIVE: 25 serves it up with a bouncy, brash new attitude all its own. Combining the power of the MARK FIVE preamp with our exclusive Dyna-Watt™ 2xEL84 power section the FIVE: 25 creates a MARK amp of unprecedented portability, clip-ability and high-speed, tactile expressiveness. It assures the MARK amp lineage will continue on past the current “little amp” trends of today to define a sonic territory and class of amplifier hard to ignore in any size or wattage category for years to come.

FRONT VIEW: MARK FIVE: 25

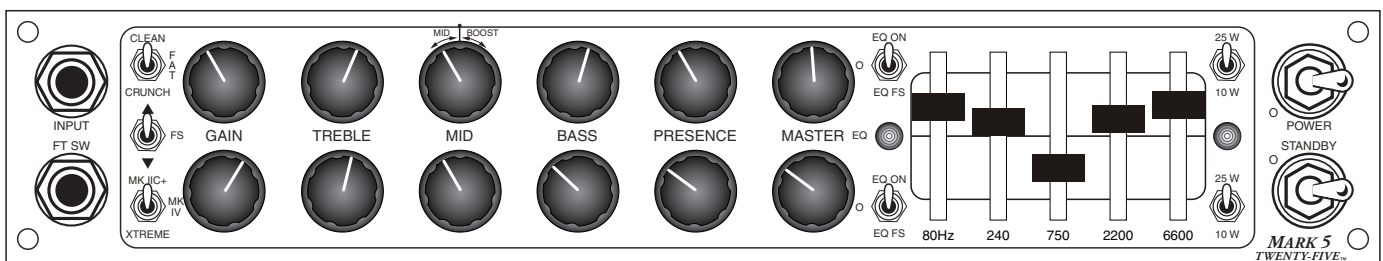

REAR VIEW: MARK FIVE: 25

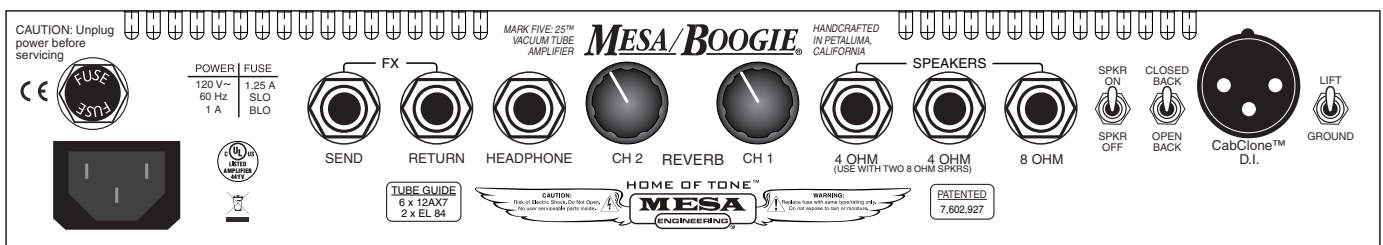

OVERVIEW: FRONT PANEL

THE PREAMP

CHANNEL 1

This Channel incorporates our best two Clean Modes ever, CLEAN and FAT from the MARK FIVE. These Modes offer two musically useful flavors of this sparkling low gain voice that benefit from 35 years of continuous refinement and take Clean sounds to a dynamic, new touch-sensitive plateau. A third “crossover” Mode is also showcased here in Channel 1 and again, it’s taken directly from the acclaimed MARK FIVE.

The CRUNCH Mode, delivered courtesy of Channel 2 in the big FIVE, covers the mid-gain ground between Clean and mildly overdriven and ultimately, with this power section, on up to the higher gain sounds of its namesake. CRUNCH by itself is worthy of—and delivers more than—most stand-alone amplifiers. It roams the many subtle transition zones between clean, mildly pushed and fully saturated with finesse and offers an expressive, touch sensitive palette with broad stylistic boundaries. Play the Blues with howling overdrive, grind away on aggressive Chunking Rhythm or rip through Lead work with more layers of smoldering gain... CRUNCH is up for it all and then some. Also, here in the FIVE: 25, CRUNCH is enhanced by the ability to blend in more power section clip at lower volumes due to its lower wattage range. The EL84s accentuated top end harmonic content adds a nice openness to lower GAIN settings and Brit-voiced shred to the higher GAIN range, making CRUNCH even more applicable and valuable. You will likely find it, as many have, one of the most useful Modes of all in this MARK’s arsenal.

Channel 1 in the MARK FIVE: 25 is fitted with an additional feature that increases both the gain and flexibility in all three of its Modes. First seen on our Carlos Santana Tribute, the KING SNAKE™, an adjustable GAIN BOOST is incorporated into the upper half of the MID Control.

What was a switchable On/Off Gain Boost feature on the original MARK I appears here (and on the Carlos Tribute KING SNAKE) as an adjustable MID/BOOST found on the MID Control. From 0 to 5.0 on the MID/BOOST you will find the normal range of a standard MID control in a condensed form. From 5.0 to 10 on the MID/BOOST a wonderful graduation of overdrive possibilities unfold that enhance gain over a wide midrange spectrum and saturate with increasing thickness.

This simple but incredibly powerful (and patent applied for) MID/BOOST feature allows you to dial-in additional gain into any of Channel 1’s three Modes ranging from subtle enhancement to substantial overdrive. This incremental saturation is perfectly suited for adding extra fur to “edge of clean” sounds, helping them transition smoothly into clip with player-directed dynamics and authenticity. It also broadens the stylistic range of CRUNCH and for some players, can add all the overdrive they’ll ever need.

When even that much gain is not enough, combine CRUNCH, the upper range of the MID/BOOST and the 10 WATT Power Mode cranked way up and you’ll be truly grinding (remember, you’re still in the “Clean” Channel)! The dial-to-taste smooth, warm overdrive found in the MID/BOOST transforms Channel 1 into a full featured (high gain) amplifier all its own and offers HUGE potential for great solo and overdriven rhythm sounds across a wide range of styles.

CHANNEL 2

Channel 2 here in the FIVE: 25 is an exact preamp replication of Channel 3 in a big MARK FIVE and is all about gain, gain and more GAIN! While it’s true that all three of these Modes are very versatile and can produce great sounds for many styles at their lower settings, it’s the higher range of the GAIN control that put them on the map and at the center of so many iconic Rock Artist’s styles. From the Stones to Metallica, Night Ranger, Lamb Of God and Steve Lukather to John Petrucci, MARK Series have made an indelible mark (no pun intended) on popular music. The soaring MARK Series LEAD and Graphic EQ/Mid-Scooped Crunch Rhythm sounds especially, have woven themselves into the fabric of Heavy Rock.

Here in the MARK FIVE: 25 that sound is recreated, celebrated and for some, even elevated, in three unique and stylistically opposing Modes. While they are labeled MK IIC+, MK IV and XTREME, they could as easily be named for their personalities... Focused, Warm and Dangerous.

The top MK IIC+ Mode In Channel 2 is an exact recreation of the iconic MARK IIC+ LEAD Mode and offers the blistering midrange

focus and searing top end of this classic 30 year-old circuit. It's funny to think of high gain sounds as Vintage (at least for us), but as surely as the bands that used them to define their sound in the '80s, along with those Artists still doing so today, the C+ is a recording dream and a Road Dog... a surviving, thriving piece of Rock History. It's urgent attack and tight midrange focus provides the perfect canvas to create, especially huge Rock and Metal sounds, with another iconic MARK feature... the on-board Boogie Five-Band Graphic EQ. The II-C+ Mode responds very well to the Graphic EQ and the ever-popular extreme settings of the 80Hz and 240Hz Sliders. The MK IIC+ is more adept at keeping things tight, tuned and chunking due to its stripped, mid-focused nature. The 750Hz Slider is the perfect tool with which to apply the precise amount of inherent midrange attack in this Mode and bring the sound forward (bumped) or push it back (scooped) in your musical landscape. Many Heavy Rock aficionados find the MK IIC+ Mode with the EQ employed their go-to sound for aggressive high gain rhythm work. For the rest it provides an articulate, singing high gain voice with tons of mid-focus clarity from which to craft your signature Lead voice.

The middle MK IV Mode is another exact recreation, this time of the MARK IV's "Lead" Channel and it appears on both the 6L6 MARK FIVE'S Channel 3 roster and here on the MARK FIVE: 25. This MARK Lead Mode is fatter and creamier than its mid-accentuated brother, offering a warmer voice that's great for both single note soloing and high gain chording. It can provide more girth and sonic width and can round things out or fill them in. It's nicely juxtaposed to the pointed, more forward voice of the IIC+ and is supremely balanced and full bodied. Because of this more filled-out footprint you may want to use less extreme settings on the Graphic EQ. Super-scooped mids on the 750Hz and/or radically boosted low end on the 80 and 240Hz Sliders may create sounds that are not as cohesive or turn "mushy" and slow, especially at higher GAIN (and/or MASTER settings). Played with or without the Five Band EQ, the MK IV Mode is a great all around choice for so many styles, low or high gain, and would be a great "if I could only have one" Lead Mode. Its warmth, balance and easy to play feel are the sonic anchor for Channel 3 in the big FIVE and even more of one here in the tighter, brighter EL84 powered MARK FIVE: 25.

The lower XTREME Mode is also a faithful duplication and taken directly from the 6L6 MARK FIVE. While its name is shorter here to fit this tiny Panel (no "E"), it definitely lives up to its name and delivers the radical dose of high gain infused with extra harmonics and even more urgent attack than its cousin upstairs, the IIC+ Mode. This hyper reactive voice jumps at the first hint of pick attack and roars with aggression. It's further antagonized by the similar response of the EL84 power tubes here in the FIVE: 25 with their fast attack, higher mid frequency and relative lack of sub-low bottom end. XTREME shreds, grinds and thrashes like the angry teen it is circuit-wise and whatever it lacks in nuance, it makes up for in brash attitude. It's very fast, forward and furious and should be used in musical environments where you don't care if you offend and/or dominate... and in fact, this may even be the goal.

5-BAND GRAPHIC EQ

The on-board 5-Band Graphic EQ has been an iconic trademark of MARK Series Boogies since it first appeared on the MARK I back in 1970. The shaping power of this feature can't be denied, especially when combined with the MARK II and IV's tight, mid-focused gain sound. In the '80s, the classic "V" setting of the Graphic EQ on MARK II and III models became an instant Classic. With bigger chunking low end, scooped mids for width and a chirping harmonic top, these MARK amps were nice alternatives to the Brit-mods of the day. They quickly took their place as the other sound in Heavy Rock, etching the on-board Boogie Graphic a nice little niche in Rock history.

While the MARK FIVE: 25 Tone Controls are accurate and effective over a wide range, they come earlier in the preamp's signal path and can only achieve so much shaping before they produce possible imbalances in certain Modes. One example might be the BASS Control in Channel 2 where, in the MARK II-C+ and MARK IV Modes, too much bass dialed up early in the preamp will cause the sound to be tubby and unfocused.

The Graphic EQ comes at the very end of the signal chain so you can shape the final sound with the only consideration being how much of a certain frequency your speakers, cabinet—and ultimately your ears—can handle. The only consideration is that here in this 25 Watt power section, extreme settings of the two lowest Bands — 80Hz and 240Hz will use up power (wattage) quickly and overall headroom will be affected. This is even more of a consideration in the 10 Watt Power setting. Dial with care and taste to ensure the best performance. Subtle movements cause substantial results here, so use this powerful tool wisely and it can take your sound almost anywhere you want to go. Just be sure to reference less altered sounds from time to time to keep a perspective, as it's easy to get an "EQ Hangover".

Each Channel is fitted with a mini-toggle just to the left of the SLIDERS to select the operational status of the 5-Band Graphic EQ and

the FIVE: 25 gives you a choice of two ways to utilize its shaping power. In each Channel you can decide whether you want the EQ active all the time in that Channel—EQ ON (toggle up), bypassed all the time in that Channel—EQ OFF (toggle center), or activated by the EQ button on the Footswitch—EQ FS (toggle down). There is also an Orange LED in between the switches to keep you apprised of EQ status that illuminates when the EQ is active, regardless of how it has been engaged.

MULTI-WATT™ Channel Assignable Power To the right of the Graphic EQ SLIDERS are the Multi-Watt™ Channel Assignable Power switches for each Channel. These allow selection of either the full 25 watts of Dyna-Watt™ power with its more-than-rated punch and impressive burst of headroom on the attack, or the brighter and oh-so-clip-able 10 watts of Class AB Triode power. The Blue LED lamp in the center of the Panel between the Multi-Watt switches is the AC Pilot light.

Dyna-Watt is the choice for the majority of those who will be gigging or rehearsing with others and provides the maximum volume for clean sounds and the tightest tracking response for high gain rhythm work, especially in the low end. This bouncy, elastic feeling power section was created in 1984 and was the engine behind our first low wattage amp the STUDIO .22, and its shocking performance. Explosive, dynamic speed, an easy to play feel and the impression of power far beyond its rated wattage have kept it at the center of our low wattage offering for 30 years now. This incarnation pairs it with the MARK Series preamp, which is also dynamic, expressive and touch sensitive and together they create an incredible playing experience that's as magic as it is portable.

The 10 Watt setting flips the 2xEL84s over to a CLASS A/B Triode wiring configuration that offers an opposite power response to Dyna-Watt along with greatly increased clip-ability. It produces a skinnier, slightly brighter response and is the same low power scheme used in our Mini Rectifier Twenty-Five and has the ability to enhance many styles. It's the perfect fit for the 6 versatile preamp Modes in this MARK rendering as well. The 10 Watt setting is great for lower volume practicing, rehearsing and recording and allows more use of the power section as a gain source, enabling you to reduce the preamp's GAIN Control settings and explore the old school approach to achieving tube overdrive... power saturation.

With the POWER switch to engage AC power from the wall and the STANDBY to allow tube warm up at cold-start and cool down at set breaks, the tour of the Front Panel is complete. Now let's review the Rear Panel and explore the MARK FIVE: 25's comprehensive list of interfacing and Effects possibilities.

OVERVIEW: REAR PANEL

The first feature of note starting at the far left is the Series, Fully Buffered, Tube FX LOOP. This is the interface point for outboard processing and it provides a junction between the preamp and power section. The LOOP performs well with both Rack and Pedal type outboard gear with the obvious exceptions being those effects that work better on the INPUT of an amplifier (Wah, Compression, Gain and Overdrive Pedals, Envelope Filters, etc.). Since it is buffered, you can use multiple units in line and relatively longer lengths of cable (25 feet or less) before hearing too much degradation in signal. Lengths longer than 25 feet may warrant including an additional Buffer or Line Driver to preserve your Tone. Though it goes without saying, we'll say it here anyway. The MARK FIVE: 25, despite its tiny size, is a professional amplifier. Use high quality, professional Effects Processors when interfacing to your FX LOOP or the likelihood of diminished performance and poor sound quality will be increased.

HEADPHONES

The FIVE: 25 features a HEADPHONES Output for personal enjoyment of the amplifier when it is not possible to play through a speaker. This jack derives its "speaker simulated" signal from the included CABCLONE™ D.I. feature and delivers a surprisingly good rendering of the FIVE: 25's sound and feel to your headphone set of choice. The playing volume is determined by the MASTER control and you will need to adjust the volume there as this circuit is passive and has no op-amp driven volume control. Remember that headphones can vary greatly in both sound and efficiency and therefore the performance of the HEADPHONE jack can be optimized or compromised by the headphones connected to it. We recommend trying a few sets of different types and manufacturers with the MARK FIVE: 25 before choosing headphones for this application. In our tests, we've found that lower impedance Headphones tend to offer the best performance in terms of available output and Tone.

ALL-TUBE, SPRING REVERB

Next up is the REVERB section, which offers individual control for the REVERB MIX in each Channel. This allows different amounts of the all-tube, short-spring analog Reverb to be dialed in for each of the FIVE: 25's two Channels. Anything from a subtle background ambience to a fully drenched effect can be dialed according to taste and musical style and the inclusion of this traditional analog spring Reverb further underscores the professional legitimacy of this MARK model.

SPEAKER OUTPUTS

The MARK FIVE: 25's SPEAKER interface is also taken straight from the 6L6 MARK FIVE and offers our time tested 1x8 Ohm and 2x4 Ohm SPEAKER OUTPUT jacks. This combination enables proper impedance matching with a wide range of cabinet options and speaker load impedances and ensures you'll have great performance regardless of your cabinet choices.

Introducing The CABCLONE™ D.I.

And last but DEFINITELY not least is possibly the coolest feature ever to grace a MESA Rear Panel, the on-board CABCLONE D.I. and Cabinet Simulation feature. This built-in magic recording solution allows you to capture a wonderful representation of the sound and feel of the MARK FIVE: 25 direct to a Console, Converter or even direct to a Recorder without the need to mic up a speaker.

Taken directly from our acclaimed stand-alone CABCLONE™, this compensated D.I. (and HEADPHONE Output) does an incredible job of capturing the signal from the SPEAKER OUTPUT and turning it into direct injection gold. The four elements here allow for use with a live speaker or without, so you can blend the direct signal and a mic'd speaker cabinet if you so desire. The CABCLONE section features switches for SPEAKER Status (ON/OFF), CABINET Style (CLOSED BACK/OPEN BACK), GROUND (LIFT/GROUND; Pin 1 Float) and an XLR BALANCED Output. This array of controls comprises perhaps the most valuable and welcome feature set on any MESA amp and greatly expands both the functionality and enjoyment potential in both live and recording applications. The MARK FIVE: 25 is the first of our amplifiers to include this powerful tool built right in for speedy and convenient capturing of this new MARK's sound without sacrificing authenticity and Tone. It's sure to increase the professional potential of this little dynamo and help this ultra-compact MARK usher in a new era of MESA performance as well as raise the bar even further for amplifiers in its category and beyond.

Now that we've reviewed the Features and Controls of the MARK FIVE: 25 globally, let's take a closer look at the individual controls to see how they interact to create the sounds YOU want to hear.

GETTING STARTED

1. Connect the A.C. Cord to a grounded (3 pin) A.C. outlet.
2. Connect your speaker cabinet of choice to the proper matching impedance SPEAKER OUTPUT on the right side of the Rear Panel. An 8 Ohm load is preferable for your first experience with the MARK FIVE: 25, as you will then be able to experience the full power (wattage) potential and best Tonal balance.
3. Connect your Instrument to the INPUT jack on the far left of the Front Panel using a good quality, shielded, Instrument Cable (grounded type) of preferably no more than 12–15 feet. Longer cable lengths will begin to compromise the sound and roll off top end due to increased capacitance.
4. Unpack and Connect the MARK FIVE: 25 Footswitch to the FT SW jack at the far left bottom corner of the Front Panel using the supplied Stereo (Tip, Ring, Sleeve) Cable. Set the 3-position FS mini toggle (in the center of the Channels) to “FS” (center position) to use the Footswitch to access the Channels. If you don’t want to use—or don’t have—the Footswitch, use the FS mini toggle to access the two Channels by moving it up to access Channel 1 and down to select Channel 2.

NOTE: The FS mini toggle must be in the CENTER “FS” position for the Footswitch to select the Channels.

5. Flip the POWER Switch to the (right) ON position while leaving the STANDBY Switch in the (left) STANDBY position for at least 30 seconds. This allows the filaments in the tubes to warm up before being put to use with high voltage.

NOTE: Following this cold-start procedure every time you power up will increase the toneful life of your tubes.

6. If you intend to connect processing devices to your loop, do so now and refer to the FX LOOP section in this manual for proper connection and operation, although we recommend auditioning the MARK FIVE: 25 without processing for the first time.
7. Follow the Sample Settings examples below and set the Controls at these approximate settings for a tour through your new world of TONE. Remember these are just a glimpse at the vast possibilities and are meant to give you a taste of one possible way to set up your Channels. Feel free to fine-tune the sound as you go...you can’t hurt a thing and you will be learning by feel...the best way.
8. Flip the STANDBY to the ON (up) position and enjoy the ride!

SAMPLE SETTINGS

Below are a couple of different ways to set up the two Channels for Channel Switching sound (Mode) choices. Remember, there are countless ways to set up the Channels and after reading the rest of this Operating Guide, you will be well equipped to dedicate the Channels to your footswitchable needs quickly and effortlessly.

Mark Clean/Mark IV Lead

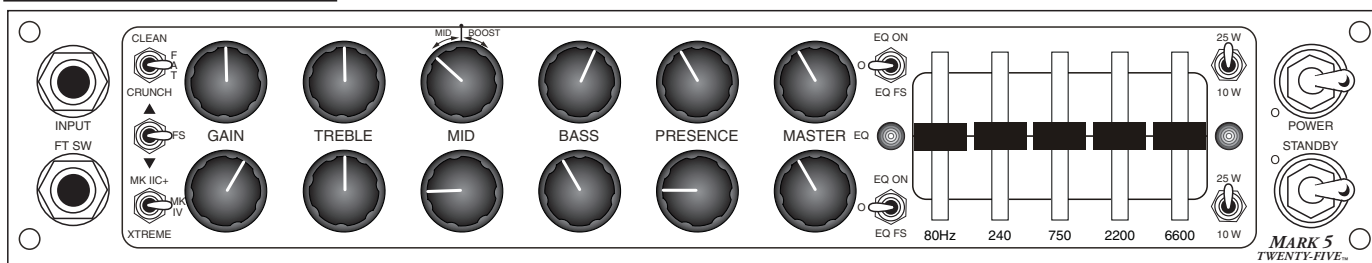

80's Crunch/XTREME Lead (EQ Optional)

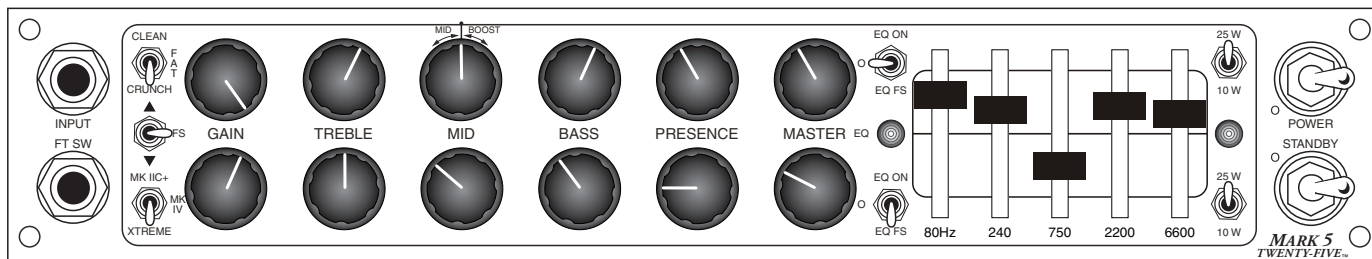

HELPFUL HINTS

NOTE: REDUNDANT INFORMATION: Throughout this Operating Guide you will encounter redundant information and sections that are repeated for your continued awareness and as reminders. This is done so a person can read only the sections they are interested in, and yet still get the important points they should know or NEED to know about the MARK FIVE: 25. We apologize if this gets annoying for the cover-to-cover reader (often our most loyal fans and MARK aficionados), but even they may appreciate it some time in the future when referencing this Guide quickly for a specific topic.

- If you have everything on POWER, STANDBY, GAIN and MASTER (as well as Input and Output Volume Controls on any Effects in the LOOP) and get no sound; Check the SPKR ON/SPKR OFF switch in the CabClone™ Section at the far Right of the Rear Panel (when looking at the back of the amplifier) to make sure the toggle switch is set to SPKR ON. This may have been bumped during shipping, transport or set up.
- The MARK FIVE: 25 will sound better and feel better to play if you have at least one speaker cabinet touching the floor you are standing on while you play. The coupling effect and especially the transmission of bass frequencies will cause the amp to sound fatter and the strings to feel more substantial and tangible when the amp (or cab) sits on the floor... wood floors like stages are really great! Let's face it... the guitar can be one of those weird instruments that rarely feels the same way two days in a row, night to night, and from room to room and we guitarists can use all the help we can get, right? This "coupling" effect usually helps... with the only exception being a stage filled with too many live mics. Sometimes you are then forced to lift the amp to minimize the coupling effect and/or associated resonant feedback.
- Remember the MARK FIVE: 25 is a high performance amp in every sense. Just like a highly tuned car, you don't need to drive it "wide open" to have fun. You can get amazing performance in the middle ranges of all the controls. Yeah sure, there are times when you are going to run flat out...but just like the car needs special tires to run flat out, it takes a really stable set of preamp tubes (ones that exhibit little or no microphonic tendencies) to do that.
- Use the STANDBY switch every time you power-up, during set breaks, cable hook-ups and anytime you are not playing for a few minutes. Doing so will increase the Toneful life of your tubes.
- The Front Panel CHANNEL SELECT mini toggle (located between the two Mode switches at the left of the Front Panel) must be set to the CENTER FS position for the Footswitch to select the Channels.
- The GAIN and TREBLE Controls are the most powerful tone shaping controls in each Channel and should be used with taste. They determine much about the attack characteristic and the overall personality of the sound in all the Modes. Many of the great sounds in all the Channels will find these two Controls in their middle ranges. Avoid setting the TREBLE high (above 2:00) when the GAIN is to be set high as this brings about the tendency for a slightly microphonic tube to ring or squeal.
- The "normal" range of a MID control in Channel 1 appears between 0 and 5.0 in a more condensed taper. Above 5.0 the BOOST feature takes over and adds incremental gain in the midrange frequencies while diminishing the effectiveness of the Tone Controls.
- When using high GAIN settings, try the 5-Band Graphic EQ for adding extra top end as it comes later on in the signal chain and will be less stressful on the preamp tubes in many cases.
- When applying the 5-Band Graphic EQ, remember to go back and reference the "flat" (no EQ) sound to keep a clear perspective on what you are doing to the sound. It's VERY easy to get lost in the old "more, more, more" syndrome, tweak until there's all EQ and no Tone, and wind up with an "EQ Hangover". Referencing a "flat" unaltered sound with the EQ toggle switches or the Footswitch will help you avoid this common pitfall.
- The PRESENCE is very powerful at shaping the voicing of higher gain sounds in both Channel 1 and 2. Set low it fattens and compresses the sound, making for a more voice-like, focused note. Higher settings "open up" the sound and allow the full spectrum of harmonics to flow through. Use this control to fine tune your overdriven rhythm and lead sounds after you have dialed the rest of the preamp controls to your liking.
- You will likely experience a volume increase when selecting the Channel 2 XTREME Mode from the two prior Modes in that Channel. This is normal and a result of diminished negative feedback and the resulting increased sensitivity in the power section.
- Beware of very high settings on the BASS control in Channel 2, especially when the GAIN is set high. Too much BASS will produce

a tubby, indistinct attack and slow the response. A basic rule might be this; As the GAIN goes up...the BASS should come down.

- Beware of setting the EQ SLIDERS to extremes when using the Channel 1 FAT Mode. Be especially careful of the 80Hz and 240Hz, as these two can dump excessive amounts of low frequencies into the mix. This, combined with the high gain settings of this Mode, can cause flub and mud in the sound and could possibly even damage some low wattage speakers if played at very high volumes.
- Speaker Impedance has a sonic effect on the sounds as the MARK FIVE: 25 power section is switched between its two different Modes. We prefer a matching 8 Ohm speaker load connected to the 8 Ohm SPEAKER OUTPUT for the most balanced sound and overall performance. A 4 Ohm Load will work fine, but will usually sound a little “softer” and more scooped with less “punch” in the midrange frequencies.
- You can safely experiment with different load combinations in the high direction, for example an 8 Ohm Speaker Cabinet connected to the 4 OHM SPEAKER OUTPUT jack on the MARK FIVE: 25, or a 16 Ohm Cabinet on the 8 OHM SPEAKER OUTPUT. You can't hurt your amplifier loading it in that direction and you may discover an impedance scenario that, though a technical “mismatch”, produces a unique response that fits your needs. The only penalty might be that your power tubes may wear a bit faster with mismatched load conditions and you won't achieve the amplifier's maximum headroom (full power output). Do Not use an impedance mismatch in the low direction (example: a 2 Ohm Load on a 4 Ohm SPEAKER Output) as this is very hard on the Output transformer and may cause damage to the amplifier.
- Because the MARK FIVE: 25 is a lower wattage amplifier, and therefore you will likely be hearing more of the power section (and it's overdrive effect) than you might when using say a 50 or 100 watt amp, you may want to try setting the preamp GAIN Control in the Channels a little lower than you are typically used to doing. This may help you retain more attack and fundamental punch in the sound and keep things tight and focused. This little MARK has immense preamp gain available and it may not be necessary to use higher amounts of it all the time to achieve the best sounds and performance.
- When reaching over the top of the amplifier from the Front, the REVERB Controls are in the center of the Rear Panel with Channel 1's REVERB Mix on the left and the REVERB for Channel 2 just to the right.

FRONT PANEL

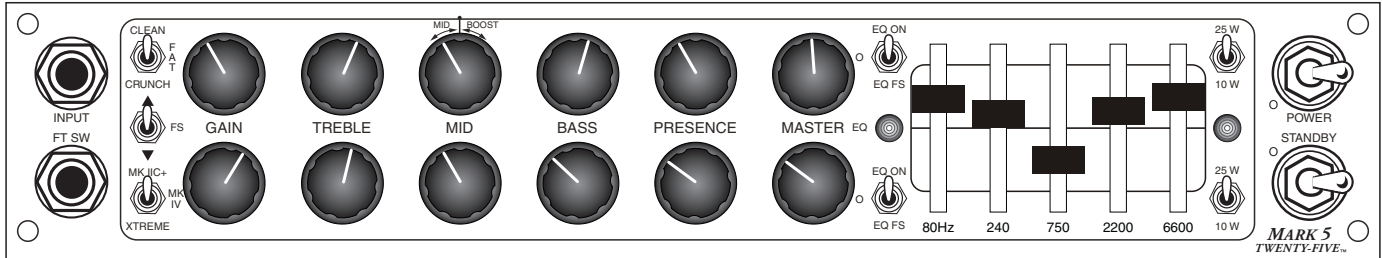

THE CHANNELS: MODE BY MODE

The Channels of the MARK FIVE: 25 are each extremely versatile and therefore it is not entirely fair to categorize them as Rhythm and Lead. Most players will initially assign Channel 1 to some sort of clean sound and Channel 2 to an overdriven chording sound or a single note solo sound. While there is nothing wrong with this scheme, and in fact the Channels DO lay out nicely for this approach, it is also true that both Channels are equally adept at all three types of sounds. In other words, Channel 1 can produce great crunch rhythm and overdriven Lead sounds, and Channel 2 boasts some amazing low gain “threshold of clip” sounds. So the lesson here is not to label the Channels as to sound style, and perhaps think of them more in terms of their individual gain structure... “lower” and “higher”. This type of thinking will help you to not limit yourself when searching for sounds and we encourage you to think outside the box and use your imagination when dedicating the Channels for your needs. The Five: 25 was created to be an instrument of limitless expression and possesses all the gain and shaping power in its two Channels to take you anywhere you wish to go in the world of Tone.

Here is a “shorter” reference guide to the Channels and how they lay out in terms of gain structure. How you wish to assign them to your needs is up to you and discovering that... well that’s where the fun begins.

CHANNEL 1

This is the lowest gain of the two Channels in the MARK FIVE: 25. Two Modes **CLEAN** (switch up) & **FAT** (switch center) are structured with lower gain clean sounds being at the forefront of their responsibilities. These two modes are well described by their names... as in **CLEAN** produces sweet, sparkling low gain beauty and **FAT** adds big, lower (frequency-wise), low end and breathiness to that sound. These two have the greatest headroom, the most dynamic range and Input Stage sensitivity in the entire amp. They are the least compressed and retain the fastest attack characteristic. They would be considered as based on “vintage” architecture.

The medium gain **CRUNCH** Mode (switch down) is dedicated to pushed, overdriven “Crunch Rhythm” sounds and is the bridge between the top of Channel 1’s maximum gain region and the taking-off point for Channel 2’s high gain structure. It took no small feat of engineering to include this super musical, “in-between” Mode in Channel 1’s palette and achieve the correct tapers on critical shared Controls while still offering a seamless overall response and feel. **CRUNCH** would stand proud as the **ONLY** Mode on any amplifier and adds immense versatility to the arsenal of great sounds in Channel 1.

CRUNCH adds gain across the spectrum but increases gain in the low mids and adds fatness, which creates a smoother sound when clipped. This added gain slows the attack a bit, but in turn adds sustain and girth. A balanced dynamic content makes it work equally well for both broken-up chording and urgent single note soloing. This medium gain and dynamic range is the perfect transition between a “vintage” gain structure where overdriven clean sounds are the maximum available, and a modern “high gain” preamp like Channel 2’s Modes where the added tube stages more fully saturate the signal, slow the attack and compress even more. **CRUNCH** is likely to be all the gain/overdrive aficionados of the more traditional gain structure will ever need.

Again, remember that in all three of Channel 1’s Modes, you will likely hear more power section drive and saturation than you may be accustomed to in higher wattage power sections. This may warrant a more conservative application of the preamp’s **GAIN** control to achieve the sounds and the attack characteristics you are used to in those higher wattage amps. So keep that in mind when dialing in the three Channel 1 Modes for your applications.

CHANNEL 2

This Channel is the higher gain channel of the MARK FIVE:25 and is dedicated to creating the best saturated gain sounds from our fabled MARK II-C+ and our MARK IV. Though the entire channel is aimed at high gain sounds, many expressive and dynamic medium to low-gain sounds can also be found here with the GAIN control set lower (below 11:00). Again, this channel defies classification as to style and is extremely versatile for both lower and high gain, chording and single note sounds.

IMPORTANT! Remember, as in Channel 1, you will likely be hearing more power saturation and Drive for a given volume than you would in a higher power amplifier. Keep this in mind when setting the preamp's GAIN Control in both Channels—but especially here in Channel 2. It's really easy to go overboard, dial in too much GAIN, soften the attack, and turn everything to "mush". Do yourself a favor... remember this is a low wattage amp. Let those little EL84s back there work for you! These tubes clip in a beautiful and well-behaved manner with a less bloated low end, more high-mid "bark" and a nice harmonic "shred layer" up top than their octal socket bigger cousins, so allow them to comprise a bigger part of your overall gain structure and take it easy on that GAIN Control. Your sound will be tighter, more distinct, and more dynamically responsive.

MARK II C+ is exactly that. This Mode is a faithful—down to the last detail—recreation preamp-wise of the LEAD Mode of this legendary circuit. Blistering focused gain and explosive attack that gives way to morphing harmonics are its soulful signature and after 30 years, these sounds remain at the forefront of many Rock styles. The tight mid-punch focus of this sound provides an open canvas for coloring with the Graphic EQ and the classic "V" setting has become a staple ingredient of the II-C high gain sound for Heavy styles.

MK IV is a faithful re-creation of the MARK IV's LEAD Channel. Because of the vast options in configuring this channel on the MARK IV, combined with the fact that the MK II C+ Mode covers a wide range of brighter sounds, we have configured this Mode for a slightly warmer, creamier sound. The MK IV Mode has a substantial increase in midrange gain that creates the impression of a roll-off in the upper harmonics resulting in a huge, wide sound. As we said in the OVERVIEW, this Mode would be the choice for an Extended-Stay, "If I could only have one Gain Mode", Desert Island gig because of its balanced, warm blend, full, rich character and easy to play feel. It also works extremely well with the 5-Band Graphic EQ and can be used to create some really nice furry, edge-of-clip sounds in the lowest region of the GAIN Control that are just a bit smoother than the percussive jab of the MK IIC+ Mode.

XTREME is exactly what it sounds like...extreme! As mentioned earlier, while its name is shorter here to fit this tiny Panel (no "E"), it definitely lives up—in full—to its reputation created in the MARK IV and FIVE and delivers the radical dose of gain infused with extra harmonics and even more urgent attack than its upstairs cousins, the MK IIC+ and MK IV Modes. This Mode also takes its original architecture from the MARK IV LEAD Channel, but is voiced almost opposite of the MK IV Mode found here in Channel 2. Forward, aggressive, tight and fast are its sonic signature and it is the highest gain and loudest of the 6 Modes here in the MARK FIVE: 25. You will likely experience an increase in volume when selecting XTREME from either of the other two Modes in Channel 2, and this is after we adjusted it all we could internally without affecting the Tone. Use this mode when you want crushing impact and stop-on-a-dime dynamics. XTREME is most suited for heavy styles where maximum gain and lightning fast attack are the order of the day, but there are also some lower gain applications in the lower region of the GAIN control when transient attack and a bright character are the order of the day. Surprisingly, XTREME holds some of the best potential for "almost clean" sounds due to the harmonic content and dynamic immediacy of its nature.

NOTE: Increased sensitivity in the power section in the XTREME Mode causes a little more background noise because the power amp and driver are "listening harder" due to less negative feedback in this Mode. This is normal and no cause for alarm.

THE MODES IN DEPTH: CHANNEL 1

CLEAN

As discussed in the previous section, this is the lowest gain of the three Channels in the MARK FIVE: 25 and will cover all your “more-stripped”, brighter needs for clean rhythm and solo styles as well as slightly driven chording sounds. As with the Modes in each of these two MARK Channels, we start with the slimmer, tighter voice of CLEAN, move up the girth scale to FAT, and finally to the higher gain, mid-saturated architecture of CRUNCH... the ultimate “crossover Mode” and bridge between the vintage architecture of CLEAN and FAT and the modern gain circuits of Channel 2. Let us state again; it took no small feat of engineering to include both traditional CLEAN Modes and this “in-between” CRUNCH Mode on the same row of Controls here in Channel 1 and have the right tapers on critical Controls with a seamless response and feel. Any of these three would stand proud as the ONLY Mode on many “Boutique” amplifiers, but you get all three here in this smallest rendering of the MARK Series.

CLEAN is derived from a blend of our best MARK series clean sounds taken from the MARK IV and is perfect for rhythm comping in an ensemble environment where the guitar has to fit in a defined spot in a complex mix. It is also extremely accurate in the time domain and has a balanced blend of tight low end to the sparkling, immediacy of the top end. This mode also clips great in the 10 watt Power Mode with its well balanced, tight, urgent nature.

CLEAN puts emphasis on tight, focused clean rhythm and articulate single note playing. This mode has the greatest clean headroom of any mode in the amplifier, and though it can be pushed to clip at extreme settings (4:00–5:30), it will remain tighter and somewhat stiffer than its FAT counterpart when used for this application. The good side of this stiffness is that the BASS control can occasionally be set higher than when going for clipped sounds in FAT - because the overall personality of CLEAN is stripped of the sub-low frequencies that can be a challenge when looking for aggressive threshold rhythm sounds.

CLEAN works very well for aggressive, brash clipped chording sounds too, especially when the Power Select switch is set to 10 watts and the PRESENCE is run a bit high (1:00 - 2:30). Check out this region for Punk or super-fast Classic Rock rhythm styles where you need aggressive almost-clean sounds that will start and stop instantaneously.

CLEAN shines for chording and arpeggiated single-note work with its crystalline top end sparkle, urgent attack and high harmonic openness. With the low end tucked up higher it adds fullness, but doesn't go too low, so it won't get “too big” or sluggish and get in the way when a groove calls for precise, rhythmic note durations. CLEAN is amazing for skanky Funk rhythm or burning Country picking.

The midrange frequencies are also a bit higher in frequency in comparison to the FAT Mode, enabling CLEAN to deliver a percussive attack that stays tight and has maximum impact in a range that cuts and “protects its territory” in a complex mix. Playing with these higher mids can be a powerful way to shape the CLEAN mode as the role they play either brings the sound forward—even in the time domain, making it seem faster—or lends a recessive, more relaxed quality to the sound... making it feel slower. Experiment with the BASS and MID controls as you will learn to tune the attack, width and girth of the sound in CLEAN to match the style and tempos you play most.

FAT

FAT stands in sharp contrast to CLEAN with a big breathy bottom end that extends down into the sub-low region (as much as these little EL84s can deliver anyway). This adds “air” to the entire spectrum but especially the bottom and top end get more bubbly and spatial. This sound relies heavily on architecture from the INPUT 2 of our original MARK I. FAT excels at big, featured chording parts and single note clean soloing and is also a great choice for clipped sounds (with the BASS control set low) in the 10 Watt Power Mode.

FAT is in every way opposite to the tight, bright voice of CLEAN. This circuit pays homage to the early Black Face '60s era circuits pioneered by Leo Fender and this classic voice has become tightly interwoven into the fabric of classic Rock and Blues sounds. Sweet shimmering highs that soar up where angels fly, yet ring with bell-like authority low enough for you and the rest of the band to appreciate with cut and presence. Proud mids that are punchy and tight, yet are low enough to carry weight and add girth. Big, airy lows that start at the center of the earth and bring the biggest fundamental possible from these little power tubes and get the party started in a hurry. These qualities produce an easy to play feel on the strings that invite you in...coaxing you to play your best and of course... with soul.

FAT works great for chording and rhythmic work, but in contrast to the CLEAN Mode, FAT sings with a huge, lush voice that fills-in a mix and casts a halo of harmonic richness around the entire instrument. The sonic footprint is much wider and can carry a part such that it becomes the backbone of a song without any processing.

The gain structure of FAT is tapered so that it's more suited to threshold and clipped sounds with more gain lower, and presenting sooner on the GAIN Control. As FAT is pushed toward clip, the bigger cathode values in the preamp deliver a smooth, rich break up that is usually preferable for both smeared chording and bluesy single note solo work. This extra gain down lower fills-in all the jagged edges in chords and lends girth to the single notes. These qualities cause many players to choose FAT as their go-to Mode for mildly overdriven sounds that are more "purring" and less pointed and jabbing. FAT is really useful in the studio for both clean and slightly driven parts as well, where you want to have a big sound and yet retain all your dynamic nuances. This is especially true in the 25 Watt setting of the Power Select switch, where the power section can deliver dynamic differences more effortlessly due to increased headroom.

One important thing to keep in mind is that the lower centering of bass frequencies makes it possible to overload both the preamp and speakers quite easily by setting the BASS and MID Controls in their higher regions (above 11:00). The power section isn't immune either as the extra lows will use up power quickly (it takes more wattage to amplify low frequencies) and along with premature clip, you will create a tubby, indistinct sound that is not very pleasing. Follow the simple rule we suggested earlier in the HELPFUL HINTS Section of this Operating Guide; As the GAIN control goes up—the BASS (and MID in this case) should come down. This will help you avoid overloading your entire rig with lows and avoid tubbing-out your sound.

NOTE: Lower frequencies produced in the FAT mode can create a bottom heavy, flubby sound that can overwhelm your speakers and eat up headroom if the BASS (and MID) control is set too high, especially in combination with high GAIN settings. It is normal—and in fact suggested—to run lower BASS (and even MID) settings (10:00- 7:30/OFF) in the FAT Mode as the GAIN is increased.

CRUNCH This mode is taken directly from the MARK FIVE™ and here it represents the perfect "crossover Mode". It's got girth and is balanced frequency-wise and CRUNCH provides a sound that still has urgency and dynamics, yet is warm, rich and is adept at covering the valuable ground from the onset of clip up through grinding Heavy Rhythm. This makes CRUNCH one of the most versatile Modes in the entire amp and despite its name, this sound works equally well for both chording, Rhythm and single note Lead work.

You will find that the TREBLE control can be used in the higher range without becoming too bright. This region will add more gain in the top end, but you can blend it nicely by reducing the PRESENCE Control if it gets too bright. Conversely, the BASS can be reduced in CRUNCH to get some increased tightness and yet the overall character remains warm with plenty of low end inherent in the basic character.

CRUNCH also works beautifully in tandem with the Channel POWER SELECT switch when the GAIN Control is applied with common sense. Again, let the EL84s add some gain in the power section and reduce the GAIN Control in the preamp to unveil sounds that have both thickness from the preamp and attitude from the power section. Some amazing sounds arise out of the 10 watt Power Mode when CRUNCH is used this way. This applies to both chording and single note sounds.

The MODES IN DEPTH: CHANNEL 2

Channel 2 in the MARK FIVE: 25, taken directly from the MARK FIVE's Channel 3, is a tribute to the entire line of MARK series Channel Switching amplifiers and contains three circuits from the pinnacle of that architecture. The two most sought after of these, the MARK II-C+ and the MARK IV, provided both the starting points and ultimate reference for this collection of Modes. These two amplifiers share a long and prestigious list of credits and together are responsible for some of the most iconic high gain guitar sounds ever recorded. Channel 2 contains the LEAD Channel of the II-C+ and two Modes from the MARK IV, LEAD and LEAD EXTREME. These are all faithful recreations that benefit from our 45+ years of super-tuning high gain tube amps. The trade tricks, hidden secrets and even the happy accidents we've uncovered along the way have all been employed in creating these ultimate MARK sounds.

Repeat (Almost) From Previous THE CHANNELS Section; This is the highest gain of the two channels in the MARK FIVE: 25 and would be thought of by many as the Lead Channel, however there are as many ways to apply these versatile sounds as there are people who use them. The trademark mid-focus to the gain lends itself equally well to both chording rhythm and single note solo sounds because of its articulate, tight-tracking response and lush harmonic layering. These circuits also provide amazing resolution across the gain scale with great threshold-of-clip, pushed, clean sounds found at the low end of the GAIN control and searing, explosive lead sounds at the high end. Between those regions a whole range of urgent, tight, crunch rhythm sounds can be found. This fine resolution of gain and clear definition makes Channel 2 easily as versatile as Channel 1 and you'll have hours of fun exploration ahead of you as you learn how best to utilize these powerful Channel Modes for your needs.

MK IIC+ This is a recreation of the much sought after LEAD Mode circuit of this two channel MARK series amp produced in the mid eighties that became the voice of choice for so many recording artists of the day. Today there is a hard-core cult following for these vintage II-C+'s and—when they can be found—they bring 3 - 4 times their original price. Many artists even now have standing orders with their techs to buy these amps wherever they are found, regardless of price. There will probably be those who tout the tone and authenticity of their prized vintage gems (yes, we are pleased and flattered)—and just like vintage guitars—this will probably always be the case. However, rest assured, you now own a MARK II-C+ down to the last circuit detail (preamp-wise) and though you have EL84s powering your IIC+ here in the MARK FIVE: 25, the basic character is intact. And far better... you don't have to compromise your clean or lead sound because they share controls as they did in the original MARK IIC+ layout!

The II-C+ trademark sound is urgent and stripped but also has incredible focus despite its precious multi-dimensional layers of upper harmonics. It works equally well for both aggressive high gain chording and blistering single note soloing in low or high regions of the GAIN control. When dialed in here (GAIN 11:30–1:30, TREBLE 12:00–1:00, BASS 10:00–12:00, PRESENCE 8:00–10:30), it has a lead voice that is unrivaled in articulation, nuance and time domain accuracy in the high gain genre. These qualities are especially favored by those players whose technical ability demands instantaneous response and tight, detailed tracking of the pick attack. After the attack, a beautiful morphing of harmonics occurs and the notes segue through a whole range of dynamic and frequency changes that is a joy to experience. You will likely find yourself playing like never before and reaching newfound depths of expression.

For high gain rhythm work the II-C+ unleashed the other sound in '80s Heavy Rock Crunch. More complex and harmonically layered than its British fueled counterpart, the IIC+ comes on like a grinding wall of gain that is truly menacing. This mid-heavy aggression and sheer size is made even more impressive with the application of the on-board 5-Band Graphic EQ. The shameless scooping of mids and rebellious boosting of both lows and highs simultaneously led to the iconic "V" curve becoming so popular in the eighties recordings, that it became synonymous with the II-C+ sound. This sound reached further notoriety and became referred to as "Boogie Crunch" and later the "California Sound".

Throughout the nineties our Dual Rectifier's sub-low enhanced grind and punishing blend of attack and harmonics became the Pop-Metal and Grunge sound of the decade. However, there remained a strong cult following for the MARK Series/Graphic EQ Crunch rhythm sound (also re-introduced in the MARK IV) and this tighter, more articulate sound is now a classic and here to stay. In the current decade the IIC+ sound has become the crunch of choice for Prog, Punk, Indie Rock and Nu-Metal, chosen once again for its ability to stay glued to the pick attack and track tightly even at burning tempos.

There are no real danger zones or pitfalls with the C+ Mode settings-wise other than the obvious ... turn the BASS control down in proportion to an increase on the GAIN control. Also, don't try to run the GAIN maxed out with the TREBLE and/or PRESENCE way up as preamp tubes will most likely not handle this abuse and begin to show their individual tendencies toward microphonicity.

Hints For The Best Results With The MK IIC+ Mode

- Use the Graphic EQ if you need extreme low end with high GAIN settings - this comes later in the circuit and will have less tendency to get loose and tubby than that of the rotary BASS control.
- Work with the GAIN, TREBLE and PRESENCE in finite increments when searching for your ideal lead voice as these interact greatly and have a big effect on pick attack sensitivity and focus.
- The PRESENCE compresses things in its lower regions creating a more voice-like character and opens up the upper harmonic region in higher settings creating a more cutting, blade-like attack.
- For lead sounds; roll in the amount of BASS you want after fine-tuning the attack signature with the GAIN, TREBLE and PRESENCE. Fill things in just enough but don't create flub. The MARK Series BASS control brings in beautiful rich low end, but can also overtake the balance set by the other controls quickly and degrade or "slow" the attack characteristic.
- Don't overlook this Mode for lower gain sounds! Because of the harmonic content and instant attack properties, the C+ Mode excels at low gain Blues sounds—both rhythm and single note—and can even produce some great threshold of clip, almost-clean sounds. It's open and dynamic and responds great to plucking techniques as well.
- Traditionalists have commented on how well the "guitar volume knob" or "old-school channel switching" approach works with this sound. With the GAIN set low enough, the IIC+ Mode works great just backing off for clean and cranking up for lead on the guitars' Volume pot. When the GAIN is this low you can also dial in more BASS on the rotary control to add warmth and three-dimensionality without the tubbiness created at higher GAIN settings.

This is an addicting mode to play and one of—if not the—most expressive of the 6 Modes in your MARK FIVE: 25. Do yourself a favor and spend some quality time exploring how the controls interact... once you dial it in for your individual style, we all but guarantee magic will happen.

MK IV This Mode revitalizes another MARK Series amplifier and brings its iconic sound forward for this—and future—generations to enjoy with a whole new attitude, voice and portability. The big MARK FIVE's predecessor, the MARK IV, was built continually for eighteen years, all that time winning new fans around the globe, proving that the MARK Series sound can't be outdated by changing styles, trends or advances in technology. It's a classic and here to stay.

In comparison to the MARK II-C+ Mode, the MARK IV Mode is infused with more low mid and has an attack characteristic that is wider, less pointed and perhaps a bit less focused in the upper midrange. The bottom end goes down lower and it has more gain as well, giving the sound thickness and girth that produces huge, ominous crunch chords and smooth vocal single note sounds.

These circuit differences create a different feel as well, and the MARK IV Mode feels creamier and gives the impression of less resistance on the strings—making it easier to play for many guitarists. The slightly less-instantaneous attack created by the addition of low end makes the MK IV Mode feel a little "slower" and less like your picking technique is "under the microscope" which can be either freedom or lack of definition, depending on your point of view and stylistic needs. Either way, it's a nice contrast to the mid-focused, jabbing attack of the MK IIC+ Mode and will undoubtedly find its place in your musical needs.

For lower gain sounds the MARK IV Mode will have more air and three-dimensionality than its IIC+ counterpart. Some nice purring threshold-of-clip sounds can be found with the GAIN set very low (9:00–10:00) and the TREBLE around 12:30. With the GAIN this low you can again, like the IIC+, dial in quite a bit of BASS (11:00–1:30) before things get too tubby, letting you really move some air. This is a great region to explore the Multi-Watt Power Modes. The 25 Watt setting will produce a bold, punchy sound that will let you stab with authority. The 10 Watt setting will give you a more laid back attack characteristic and a more harmonically complex voice filled with low power nuance and an easy to play feel.

High gain sounds in the MK IV Mode are fat! The lower bass frequencies combined with the added gain in the low mids makes for the biggest crunch chording sounds in the entire amp. In these applications you will have to watch the setting of the BASS control more carefully as the lower frequency bottom end can get bloated much faster. If you are looking for huge bottom end with high gain settings, it is wise to turn to the 80Hz and 240Hz Graphic EQ SLIDERS. The BASS control dumps too much sub-low into the signal

path at a point earlier in the preamp to get the job done correctly. This “early bass” gets amplified over and over until it turns to flub, where as the Graphic EQ comes at the end of the signal chain and adds low end to the “finished preamp sound”.

IMPORTANT! A Few Words On Pickups

Pickups are a huge factor and ingredient in the overall character of your Tone. Many players stick with one instrument for all styles and if they are having trouble dialing in a sound on their amp, (we’ve found through helping people over the decades) that they often overlook the fact that the sound begins—and is largely defined by—what is sent to the amp from their instrument.

High gain sounds are especially sensitive to the output (strength) and voicing of pickups and even more so, to the amount of high end that is emphasized. In our experience weaker, more vintage style pickups accentuate the upper harmonic region and are wonderful for shimmering, bell-like harmonics and clarity in low to medium gain applications. When you are looking for higher gain performance, these types of pickups will present some challenges as all those upper harmonics can get buzzy and thin sounding as gain increases. You will likely find it necessary to roll the TREBLE and PRESENCE back substantially when searching for a high gain sound that is focused and pure with these vintage style and/or output pickups.

If high gain is your bag, you have probably already come to the conclusion that you need a fairly high output pickup—at least in the bridge position—to achieve the tight focus needed to produce cohesive, tight-tracking high gain sounds... especially rhythm. If not, may we suggest that you try several different higher output pickups, which tend to put an emphasis on the midrange and higher midrange as opposed to the top end. This voicing difference will produce tighter low end for crunch chords and a more voice-like single note sound for soloing.

Some of the higher output pickups will have a tap at the halfway point in the winding, giving you the best of both worlds—a switchable weaker-output/brighter sound and a full- winding/high-output setting. This is usually controlled via a mini toggle or a pull pot, but can also be hard wired to a specific position on a standard 5-way slide switch or 3-position toggle. This is a great way to have the most versatility possible and keep the high harmonic content and openness for your low to mid gain applications and then, be able to switch your guitar—in concert with the Channels of the MARK FIVE: 25—to a high output/high gain machine capable of tight, ferocious heavy sounds.

HIDDEN TREASURE: The amp you are playing through was designed to be a tool that can serve up virtually any style of guitar sound you want and set you free to play your best. It also has another hidden attribute that it may take some time—even years—to assimilate and fully appreciate.

Many of us, here at MESA and loyal MARK fans worldwide, often in retrospect realize MARK amps have the (somewhat hidden) potential to become one of your best teachers.

Sounds weird, even hokey? Maybe... but we could never count the times customers, both new and long-time Boogie-philes, write in or call and tell us that their playing and technique has improved greatly since acquiring a MARK Series amplifier. They comment that the articulate nature of the attack, incredible detail and touch-sensitivity force them to pay more attention to their technique and even phrasing because everything is so accurate. They also comment on the feeling that the amplifier is giving them back as much as they are putting into it emotionally! I (the author) am convinced of these benefits, and I know in my heart playing exclusively MARK Series amps since my early childhood radically shaped my development as a player and improved the quality and cohesiveness of the sound coming from my hands. Call me jaded, clueless or just plain spoiled, but I would much rather stay home and play my acoustic guitar than to go to a gig without a MARK Series amp.

We sincerely hope you find this hidden, subtle layer of help valuable over time, as so many of our worldwide family have, and wish that it takes your playing to places you may never have imagined.

XTREME The last Mode in Channel 2 is named appropriately and is all about more! More gain, more attack, more punishing mids, more tight, huge lows and as you have probably discovered by now, more output volume. Though it's one letter short of its forbearers' name, it performs here in the MARK FIVE: 25 with equal fury and is by far the most radical of this mini amp's Modes.

XTREME traces its lineage back to a feature on the MARK IV that resided on the Channel 3 (LEAD) PRESENCE control of that amp. A pull-pot fitted there allowed removal of negative feedback from the power section and unleashed the pent-up fury of the Simul-Class™ output.

Now a Mode in both the big MARK FIVE and this compact EL84 rendering, XTREME allows the power section PRESENCE circuit to respond to all frequencies more equally—instead of a chosen adjustable set of high frequencies—and removes an element of “control” and inherent compression in the power amp. This “wider EQ” curve in the “rear-end” creates a rebellious, unleashed and extremely “open” personality that can't be duplicated with “front end” preamp circuitry. When this radically aggressive power personality is combined with the high gain wall of layered harmonics present in the MK IV Mode, a sound of truly stunning attack and urgency is created.

XTREME in the MARK FIVE: 25 benefits from all the years we've spent creating these and other high gain modes and we've taken liberties with this tribute where there was TONE to be gained. Top end has been warmed, low end has been tightened and the feel has improved, making XTREME in the MARK FIVE: 25 easier to play and even more expressive than its MARK IV predecessor. There may be some IV owner's that prefer the slightly more notched sound of their amps, but the attack, body, elastic feel and versatility of the FIVE: 25's XTREME Mode will allow you to wield this power in more places for more styles—even venturing into some lower gain applications—where the higher wattage MARK models don't easily go.

Many devotees of Heavy sounds love the way the XTREME Mode can handle very high settings of the GAIN Control and still retain the attack and tightness for high gain chording. It is not even necessary to run the TREBLE high to achieve this tightness and settings in the 12:00–1:00 range are common. Remember that for high gain chording it is better to set the BASS control lower (10:00–11:00) and look for additional low end in the Graphic EQ 80Hz and 240Hz SLIDERS for bottom end introduced late in the signal chain that will stay tighter longer than its early preamp BASS Control counterpart.

As mentioned above, some urgent, attitude-packing lower gain sounds are possible when XTREME is used with lower settings of the GAIN control. For these types of sounds you can increase the BASS control (11:30–1:30) to add three-dimensional warmth to the sound since there is less gain dialed up and less chance of causing unwanted flub.

There will seem a decrease in the power of the rotary PRESENCE control in XTREME as negative feedback has been radically reduced in a broad range of frequencies, including those chosen for the PRESENCE circuit, which means there is less for the narrow band affected by the PRESENCE Control to work on. This is not an issue as there are plenty of highs available on the TREBLE Control and in the top Bands of the Graphic EQ to make the sound as bright as you need it.

XTREME is the most radical and over the top sound in the MARK FIVE: 25. Just when you thought you had heard it all in the MK IV Mode, XTREME comes up to challenge you with a whole new level of in-your-face, aggressive sounds. Enjoy... but employ it with a dose of mercy for the poor souls in front of your cabs or close up in the audience, as it can be a truly punishing sound when you're on-axis with the speakers.

THE CONTROLS

INPUT

This ¼ inch jack is the INPUT to the preamp. Connect your Instrument here using a good quality, shielded cable (grounded) of preferably no more than 12–15 feet in length. Longer cables may compromise the sound and roll off top end due to increased capacitance.

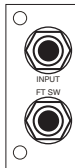

NOTE: Like every part in an electronic signal chain, cables can have a fairly dramatic effect on the sound. While we personally don't prefer the sound of super low capacitance or very EXPENSIVE "HI-FI" Instrument cables due to the over-abundance of top end they impart (to our ears) on the sound, we DO recommend using good quality shielded cables by reputable brands when connecting your Instrument.

FT SW

This Stereo ¼" jack accepts the included Stereo (Tip, Ring, Sleeve) Footswitch Cable. Connect the MARK FIVE: 25 Footswitch here and set the 3-position FS mini toggle (just to the right in the center of the Channels) to FS (center position) to use the Footswitch to access the Channels. If you don't want to use—or don't have—the Footswitch, use the FS mini toggle to access the two Channels by moving it up (upper position) to access Channel 1 and down (lower position) to select Channel 2.

NOTE: The FS mini toggle must be in the CENTER FS position for the Footswitch to select the Channels.

GAIN

This is, by far, the most powerful control in the MARK FIVE:25 and its setting determines the style and personality of all three Modes in each of the two Channels. It meters the gain in different tube stages depending on the Channel and Mode called up and it sets Input Stage headroom, which determines whether the sound will be clean or overdriven. It also acts as a subtle Tone control as the tube stages' gain is increased and decreased and imparts its own "color" on the sound.

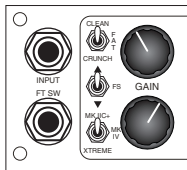

In both the Channels, there are three regions of the GAIN control. A low gain zone between 9:00–11:30, a warmer, more saturated zone from 12:00–2:00 and a higher gain zone from 2:30–5:30. Each of these zones can be used for many different applications and all can be used for both chording and single note solo work. As the GAIN control is swept throughout its range it imparts different textures and tonal characteristics.

Generally speaking, the lower end of the control (9:30–11:00) in both Channels and all Modes produces a brighter, more "open" character that has more dynamic content available. This region is great for clean, sparkling chording in Channel 1, where the maximum headroom is available, the top end harmonics are bubbly and the attack is lightning fast. The Modes in Channel 2 are tuned to deliver amazing threshold sounds in this zone where the gain is warm and furry, but there is still plenty of the guitar's personality intact. This lower zone is great for all the Channel 2 sounds when used for "threshold" chording as there is plenty of dynamics available that have not yet been compressed by saturation. You will be pleasantly surprised that the same Modes that can sound so old-school, vintage-approved and agile when set low, can produce the ferocious high gain sounds when the GAIN gets cranked.

The middle region of the GAIN control (11:00–2:00) is where the most balanced sounds live and you will find this region delivers warm, full sound, detailed attack and good dynamics with the Tone controls still having a powerful effect on the signal. The Channel 1 CLEAN and FAT Modes deliver great chording response, sound richer and have more body here. Depending on pickup style and strength you will have to watch for clipping as you are nearing the crossover point gain-wise where headroom begins to diminish in increments from here up.

The Channel 2 Modes offer up their most iconic, focused and detailed sounds in this middle zone. As these sounds are all higher gain than their Channel 1 counterparts, the best dynamic response and attack characteristics are at the lower end of this window. As you approach 2:00 there will be plenty of saturation to keep chords grinding and single notes hanging and you will start noticing increasing compression of the sound. If you aren't getting great results in this region for your gain sounds in Channel 2, you may want to look at trying some pickups with a bit hotter output. The Channel 2 Modes should be howling, burning and smoldering at the upper end (12:30–2:00) of this middle region.

The highest region of the GAIN (2:00–5:30) is all about saturation. Up here the signal gets much fatter in the low end and the top end

begins to recede to create a round, compressed sound. Dynamics become slower with lower peaks and a more legato, creamier feel is produced. In Channel 1 the high end of the GAIN control produces some great “clipped” and overdriven clean sounds as the Input Stage gives it up and starts to saturate. These sounds are further enhanced by the 10 Watt Power Mode.

Channel 2 is absolutely over the top when the GAIN is run this high. The more midrange-prominent character of these Modes allows you to still have good articulation here, even with amounts of saturation that would turn many circuits to mush. Granted, this little power section will get softer faster than its 6L6 relative in the big MARK FIVE, but the focus, articulation and tightly-glued gain that sticks to the notes and tracks tight is still there.

NOTE: Do keep in mind that, up here, you will notice the Tone controls have a diminished effect on the sound as the notes are very saturated and their character will be pre-determined by the way each Mode is voiced and how it reacts to this level of gain in the preamp. It will also depend on how much this low wattage power section is being driven or over-driven.

NOTE: Again, may we reiterate that with a low wattage power section such as this, it is often wise to run the preamp GAIN Control a little lower than you might with a high power output section (50 or 100 Watts) and let the EL84s do some of the dirty-work and provide a portion of the overall “drive” you need. Unless you are playing at very low volumes, it will be anyway. You may find this conservative approach to the GAIN control achieves a more articulate, tighter attack and a more cohesive overall sound.

TREBLE

If the GAIN is the most powerful control in the MARK FIVE: 25, the TREBLE comes in a close second. The TREBLE is responsible for shaping the character of the entire Channel/Mode. It can overpower the rest of the Tone controls easily and therefore its setting is crucial to a rich and balanced sound in all three Modes of each Channel. In fact, the TREBLE feeds the signal to the MID and BASS controls and acts like a valve for their signal strength.



When the TREBLE is set in its higher regions (2:00–5:30) it is sending a smaller signal to MID and BASS controls and they will be less active and the dominant character will be one of very bright, TREBLE-heavy frequencies. Conversely, a very low setting on the TREBLE will produce sounds that are perhaps a little BASS heavy and overly dark as a very large amount of signal is shoveled toward the MID and BASS controls. So keep in mind that setting the TREBLE with care and taste is critical for the Tone control string to work in harmony.

In both the Channels and their Modes the middle region of the TREBLE delivers the best balance and creates sounds that are plenty bright enough, but still rich and warm. We suggest that you start with the TREBLE at 12:00 and adjust up or down slightly until the desired blend is achieved. Remember that you can use the PRESENCE to add additional (and slightly higher) top end with no penalty in regards to the effectiveness of the other Tone controls, as the PRESENCE is works in a part of the circuit that is much farther down the line in the signal path.

NOTE: One of the times you may want to throw caution to the wind in regards to the TREBLE control is when you are looking for clipped Blues sounds in Channel 1 with the GAIN cranked. The additional gain that is added by running the TREBLE high (1:30–2:30) can help to saturate the Modes in Channel 1 enough to get some great pushed sounds. You will have to run the BASS rather low though (8:30–9:30) to keep things tight.

NOTE: High settings of the TREBLE (2:30–5:30) can put extra stress on (even borderline) microphonic preamp tubes (ones that are susceptible to high pitched ringing and noise) and cause them to begin ringing or show other signs of instability. Many tests were run on the set of tubes that shipped in your MARK FIVE: 25 to ensure they were stable at the time of construction. However, tubes are not perfect devices—much like light bulbs—and can change over time and become more microphonic. Luckily you can remedy most tube problems with a simple tube swap.

MID/BOOST: CHANNEL 1

This is actually two controls in one, hence the two names. In addition to the power of a standard MID control, this “ganged” two-element pot endows Channel 1 with a whole region of dial-to-taste extra gain in the warm round middle frequencies and is found on this control’s upper region (5.0–10). This feature first appeared on Original MARK I models of the seventies as an ON/OFF switch. Here we’ve given you an adjustable pot where once you had to choose from opposite extremes with an On/Off switch. As a switch this produced a huge increase in gain achieved by lifting the Tone Controls and allowing the entire signal available in the Rotary Tone Control string to “run free”. It was a great and innovative feature, especially for its time, but it had two shortcomings; One, it was all or nothing (normal or boosted) and these two were wildly different sounding due to the saturation that occurred in the BOOST position. Two; once the whole signal was unleashed by the BOOST, there was nothing much left gain-wise in the Tone Control string for the Tone controls to work on and there was little to no shaping power available in them in the BOOST Mode.



Back then everyone was so mesmerized by the newfound gain available, this trade-off seemed a small price to pay for SUSTAIN! But Here at MESA/Boogie, Tone never sleeps, so we’ve endowed this MARK model with an adjustable BOOST found here on the upper half of the MID control! It doesn’t completely solve these issues, but it does provide a middle region previously unavailable that allows incrementally added gain WITH incrementally decreasing Tone-shaping power in the Tone control string. When the MID/BOOST is maxed (set at 10), there is still very little gain left for the Tone Controls to operate on and hence they do very little. But this scheme allows YOU to choose the desired balance between the added gain and Tone-shaping power on the Tone Control string and there are some truly magic sounds in this new middle range of incremental MID gain.

From 0–5.0 the MID/BOOST works like a normal MID control, albeit with a little more condensed taper. A general settings tip for this narrower taper might be to set the MID two or three numbers below where you think your desired sound might be with a traditional style MID control.

NOTE: The “normal” range of a MID control appears between 0 and 5.0 in a condensed taper. Above 5.0 the BOOST feature takes over and adds incremental gain in the midrange frequencies while diminishing the effectiveness of the Tone Controls.

Above 5.0 the MID morphs into an adjustable BOOST control that incrementally lifts the Tone controls and allows their full signal strength to come through unbridled. Granted, some players will opt for the maximum gain possible here, and for those folks there will be the same limited power in the Tone Controls as found in the original MARK I’s BOOST Mode available to shape with. But for those players who may not the need the maximum gain BOOST at all times, there is a really usable range of enhanced gain over a broad, warm sounding region of midrange.

We are extremely pleased with the Tonal possibilities this simple but powerful improvement has made in both sound and dial-ability for lower gain “CLEAN” Modes and have applied for a patent to claim its obvious benefits as a MESA Exclusive. The simplest ideas are often the best... and easiest to walk right by for 40 years. If only the folks at the patent office played guitar... we’ll cross our fingers.

Use this valuable enhancement at-will in any of Channel 1’s three Modes to craft some amazing threshold of clip chording or Blues solo voices or apply it to already overdriven sounds to thicken them up or put them over the top. Just be aware that there is more gain here than can feasibly be applied to some GAIN settings and still retain a balanced sound with a coherent attack characteristic. In other words... don’t dial yourself into mush by adding so much gain there is no Tone left. A simple but often ignored concept.

MID: CHANNEL 2

The MID control acts much more like—and IS—a standard tone control here in Channel 2. It doesn’t have quite the massive global shaping power of the GAIN and TREBLE controls, yet the MID setting does impart a strong character on the sound of all three Modes. It brings in and out a broad band of midrange frequencies and, as we have mentioned earlier, along with these rides a fair amount of higher “low treble” range frequencies. These highs are lower than that of the TREBLE or PRESENCE but they are important for the punch and cut of the amplifier in a mix.

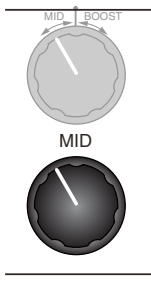

For rhythm playing in the CLEAN and FAT Modes of Channel 1, a lower MID setting (7:30–10:00) scoops some of this midrange attack and makes the bottom end breathe more. This range will also make things more resilient and create an easier to play, more elastic feel on the strings. Single coil guitars work very well here for the slinky, rubber band attack and bouncy bass character associated with Blues, R&B and Country clean styles.

The middle region (11:00–1:00) is where the punch and attack begin to come on with more urgency and this is where mahogany guitars really like to see the MID set for adding the cut and definition. Here the high mid and lower top end begins to creep into the mix of the MID controls' spectrum and chording sounds start to chime and slash with a more forward and punchy character.

From there on up (1:00–5:30) the MID introduces an aggressive range of sounds that are both full and forward as the dominant frequencies become those present under control of the MID. In this range you may choose to increase the BASS to add back in the richness and warmth that gets overshadowed when the MID control is set high. If you like the attack and urgency found in this range of the MID, all the other controls (except maybe the MASTER, which you may have to back down as the sound gets more forward) may have to be set higher to keep up with the MID dominant curve. This is fine although there will reach a point of diminishing return as the headroom in the preamp gets eaten up by this tonal “arms race” and you begin to clip the preamp with the high signal from the Tone control string.

For gain sounds in Channel 2 a similar story unfolds as the MID is increased. Lower settings (7:30–10:30) will produce wider sounding, more elastic feeling chordal sounds and the single notes will have a more creamy, smooth character. High harmonics created by the gain and controlled largely with the TREBLE and PRESENCE, will put a patina of three-dimensional haze on the sound that smears nicely when the MID is in this lower region. As the MID is increased past this region, more thick “gut punch” and low-Treble region attack creeps in and the sound becomes more forward. As the MID is cranked past 1:00 the sound gets very forward and the harmonics begin to get recessive, replaced by the punch and focus of the increasing midrange frequency bump.

NOTE: Be sure to experiment with the MID in all the gain Modes of Channels 2, paying special attention to the feel as well as the sound. The MID really changes the dynamic content as well as how the strings feel to play. Lower settings here work well for more creamy, scooped single note solo sounds, where as higher settings deliver Classic Rock crunch rhythm sounds that kick with authority and punch.

BASS

Much like the MID, the BASS control responds like a typical Tone control and blends in a fairly wide slice of rich bottom end to round out the sound. Internal switching that occurs when the different Modes are selected re-voices both the location and the frequency of bass present for each of the six circuits (Modes) in the MARK FIVE: 25. These differences are crucial to each of the sounds and a big part of their character.



The CLEAN and FAT Modes of Channel 1 incorporate a much lower bass frequency than that of virtually all the other Modes that adds depth, dimension and air to the sound. Because of this, Channel 1 needs a much slower taper pot to balance this huge low end with the sounds in the higher gain circuits. The CRUNCH Mode in Channel 1 and most all the Modes in Channel 2 utilize a much higher bass frequency. This produces a more resonant, thumping quality and keeps things tracking tighter and gives gain sounds a more bouncy, dynamic, alive feel. These higher frequencies can be used in greater proportions as compared with the lower (and sometimes more treacherous) frequencies used in the CLEAN and FAT Modes because they have less of a tendency to slow things down or get in the way during faster playing.

You can utilize higher settings of this higher frequency on the BASS control in the XTREME Mode of Channel 2 where there is a huge amount of high-mid/low-treble attack in the sound. You may want to try running the BASS in the 10:00–12:00 range in the XTREME Mode for some huge crunch rhythm sounds. If that's still not enough bottom, turn to the 80 and 240Hz SLIDERS in the Graphic EQ.

We recommend setting the BASS control in the low end of its sweep (7:30–10:00) for both single note and chording sounds whenever very high GAIN settings are in place. You can take a little more liberty with BASS settings (10:00–12:00) as the GAIN is decreased to add breath and fullness to purring pushed rhythm and Blues solo sounds.

PRESENCE

This control adjusts high frequencies above those of the TREBLE and is located in the power section, farther downstream in the signal path, and not in the preamp like the other rotary Tone controls. The PRESENCE adjusts a specific zone of frequencies in the negative feedback circuit of the power section that best suit the needs of each individual Mode. The MARK FIVE: 25 incorporates substantial circuitry to achieve the complex switching of parts needed to voice each Mode correctly and ensure an adjustable range on the PRESENCE that is sound-style appropriate as well as musically usable.



You can think of the PRESENCE as a control that allows you to either clamp the power amp down, compressing it and darkening things, or open it up and let the full spectrum of upper harmonics come blazing through. It also has a great deal to do with how dynamic the signal is and how a sound will cut through the mix in an ensemble environment.

At low settings (7:30–10:30) the sound will be warm and round with a more compressed feel and dynamic fluctuation will be somewhat limited. As the PRESENCE is increased (11:00–2:30), the top end starts to become more dominant and the compression gives way to “cut” and dynamic peaks jump out with startling speed and accuracy. At the top end of the control (2:30–5:30), a super aggressive blend of upper harmonics dominate the sound and this region can be somewhat dangerous if it’s not applied in small measures. Higher notes will slice and dice even the bravest of ears and we suggest using this region mostly in the studio for recording heavy crunch rhythm parts and even then, mostly on parts that feature the lower strings. This region, especially when coupled with the inherent curve of many of the microphones typically used in P.A. (sound reinforcement) applications, can be truly punishing.

We suggest using the lower to middle range of the PRESENCE (9:00–12:30) for the best (most balanced) sound in all of the Modes and venturing outside this only for specific applications... perhaps where you need real extremes... like an aggressive top-end peak or a really dark, highly-compressed sound.

Clean sounds in Channel 1 can often benefit from a bit higher settings (10:30–12:00) than sounds that have overdrive involved in their makeup. Once saturation begins, the frequencies carried in the PRESENCE control can make things edgy or brittle... even buzzy, real fast if you aren’t careful. Overdriven chording sounds can tolerate higher settings (10:30–12:30) better than can single note sounds, which usually want to roam the zone below 11:00 to stay round, focused and vocal.

NOTE: *The XTREME Mode in Channel 2 radically re-voices the negative feedback in the power section and inherently contains much more of this upper harmonic region than any of the other Modes. This increase in top-end cut and aggression renders the PRESENCE control less active than in the other Modes because there is so little negative feedback for the PRESENCE to work on and so much “bite” there already in the XTREME Mode’s character.*

NOTE: *Repeated Here For Awareness; High settings of the PRESENCE (2:30–5:30) can put extra stress on even borderline microphonic preamp tubes (ones that are susceptible to high pitched ringing and noise) and cause them to begin ringing or show other signs of instability. Many tests were run on the set of tubes that shipped in your MARK FIVE: 25 to ensure they were stable at the time of construction. However, tubes are not perfect devices—much like light bulbs—and can change over time and become more microphonic. Luckily you can remedy most tube problems with a simple tube swap. Avoiding extremely high PRESENCE settings can be one way of decreasing the likelihood of encountering these annoying microphonic tube problems.*

MASTER

This control determines the overall output (volume) level of each Channel and is located at the very end of the preamp.

By using it in combination with the GAIN control, any amount of preamp signal strength (within a Modes’ parameters) can be achieved at any playing volume. Once you have dedicated the Channels to their respective sounds with the Modes and Controls,



you can then balance the volume levels of the Channels using the MASTER controls. The MASTER also functions as an EFFECTS RETURN control for the FX LOOP when the LOOP is in use.



For general applications and to get the best performance out of all the Modes we recommend MASTER settings in the 9:00–12:00 range with most people settling in around 10:30 or so for average playing volumes.

Some purists like to run the MASTER all the way up and raise the GAIN until they reach their desired sound—thinking that this achieves the purest sound. In theory, they believe this resembles removing the control altogether from the signal path, and in a way it does. However, most all the vintage “non-master” amplifiers they are seeking to emulate have resistors in that place in the circuit anyway to adjust or “tune” the output of the preamp to the power section sensitivity.

The MASTER here in the FIVE: 25 is really nothing more than a variable resistor that offers an infinite range of settings possibilities and makes the amplifier many times more versatile with no sonic penalty. If you prescribe to this old school approach, then by all means, use the MASTER that way... it won’t hurt the amplifier. However, you will be severely limiting the potential sounds you can achieve by removing the nearly limitless great sounding combinations of GAIN and MASTER settings.

Do remember that in the MARK FIVE: 25, you are dealing with a lower wattage power section and this is even more applicable in the 10 watt Power Setting. To achieve the maximum headroom, authoritative punch and lively dynamic response you will need to apply the Master conservatively and with a certain level of restraint to keep from clipping the power section too early, especially for clean sounds. We've found that with medium output pickups, and mid-region GAIN settings, it is possible to reach maximum power and experience the on-set of power clip at approximately 10:45–11:00 on the MASTER Control. With hotter pickups and/or higher GAIN settings, even sooner.

5-BAND GRAPHIC EQ (Partially Repeated Here From The Earlier OVERVIEW Section)

MARK Series amps going all the way back to the original MARK I, have offered the option of including a powerful shaping tool, the Boogie™ 5-Band Graphic EQ. It was a groundbreaking feature back then that set Boogies apart from other amps of the day and continues to be one of the trademark components of the MARK Series sound. Many of the MARK sounds that have become classic over the decades have been achieved by applying the Graphic EQ and radically altering the mid-pronounced voice of the MARK preamp in favor of a more “scooped” midrange. The most popular of these altered sounds is the dropped-mid “V” curve, which makes high gain chording sound gigantic as lows and highs are boosted alongside these radically scooped mids. This “V” curve is at the heart of so many modern Metal and Heavy sounds that most people take it for granted as the inherent

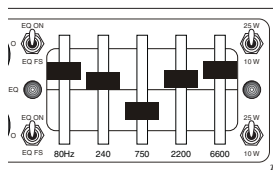

sound of MARK amps. This is not the case, but rather an example of how powerful the 5-Band EQ really is, along with a global consensus of what “Heavy” should sound like.

The 750Hz EQ SLIDER is the cornerstone of this radical sound. Dipping it below the Centerline and setting it near the lower “Cut-Line” creates a “wideness” to the sound, hollowing it out and allowing the lows and highs to become dominant. Boosting the other SLIDERS to near or above the upper “Boost-Line” increases this effect and creates a huge sound with a “hollow log” resonance in the low end and a “harmonically layered spread” in the top end. This EQ curve (V-Curve as it has become known) has been the engine behind many a Classic Rock, Metal, Nu-Metal and Prog crunch rhythm sound and continues to be the most popular application of the on-board Boogie 5-Band Graphic EQ.

If your musical style doesn't rely on these types of mid-scooped sounds, there is still incredible value in the Graphic EQ's shaping power. Virtually any frequency or characteristic you want to emphasize can be brought out and enhanced by employing this powerful broad-band shaping tool.

While the MARK FIVE: 25's Tone controls are accurate and effective over a wide range, they come earlier in the preamp's signal path and can only achieve so much shaping before they produce possible imbalances in certain Modes. One example might be the BASS Control in Channel 2 where, in the MARK II-C+ and MARK IV Modes, too much bottom end dialed up early in the preamp will cause the sound to be tubby and unfocused.

The Graphic EQ comes at the very end of the signal chain so you can shape the final sound with the only consideration being how much of a certain frequency your speakers, cabinet—and ultimately your ears—can handle. The only other consideration is that here in this 25 Watt power section, extreme settings of the two lowest Bands—80Hz and 240Hz— will use up power (the wattage) quickly and overall headroom will be affected. This is even more of a consideration in the 10 Watt Power setting. Dial with care and taste to ensure the best performance.

NOTE: *Subtle movements on the EQ SLIDERS cause substantial results, so use this powerful tool wisely and it can take your sound almost anywhere you want to go. Just be sure to go back and reference less-altered sounds with the EQ toggle switches or the Footswitch from time to time to keep a perspective, as it's easy to get an “EQ Hangover” and wind up with all EQ and no Tone.*

Each Channel is fitted with a mini-toggle just to the left of the SLIDERS to select the operational status of the 5-Band Graphic EQ and the FIVE: 25 gives you two ways to utilize its shaping power.

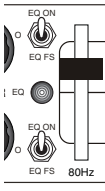

In each Channel you can decide which of three ways you want to apply the EQ:

- EQ ON** (toggle up) - EQ ACTIVE all the time in that Channel
- O** (toggle center) - BYPASSED all the time in that Channel
- EQ FS** (toggle down) - CONTROLLED BY THE EQ BUTTON ON THE FOOTSWITCH

There is also an Orange LED in between the EQ Control toggle switches to keep you apprised of the EQ STATUS. This LED ILLUMINATES WHEN THE EQ IS ACTIVE, regardless of how it has been engaged.

NOTE: Avoid using the 80Hz and 240Hz SLIDERS at their maximum boosted setting in combination with very high GAIN and BASS settings. This will not only cause an unbalanced, tubby sound (bad sound), but also possibly stress loudspeakers, especially Studio Monitors when the CABCLONE Feature is in use and the amplifier is feeding a Console, Preamp or Recorder.

NOTE: Avoid using the 2200KHz and 6600KHz SLIDERS at their maximum boosted settings in combination with high GAIN, TREBLE and/or PRESENCE settings. This may increase the likelihood of any tube that might have microphonic tendencies to start producing ringing or squealing due to excess top end. If this occurs simply back down one or more of the above preamp Controls or EQ SLIDER Bands or both, and the ringing should subside.

NOTE: Repeated Here For Awareness: Like a powerful car with a high horsepower motor can produce speeds beyond the capabilities of certain tires, the MARK FIVE: 25 can produce gain beyond the capabilities of certain preamp tubes. While the tubes in you amp passed our rigorous testing at the time of production, tubes can wear and change over time and become more prone to microphonics. Using common sense and a little “tasteful restraint” with these powerful Controls will greatly minimize your exposure to microphonic tube issues.

MULTI-WATT™ CHANNEL-ASSIGNABLE POWER

Located just to the right of the Graphic EQ SLIDERS are the Channel-Assignable MULTI-WATT™ Power Select switches. Each Channel here in the MARK FIVE: 25 allows you to choose either 25 Watts of our exclusive Dyna-Watt™ Class AB Pentode wired power or 10 Watts of Class AB Triode power, enabling you to match the power output, the feel and the amount of natural power clip (drive) to each of your foot switchable preamp sounds.

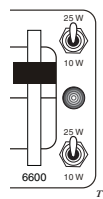

The **25 W** setting (switch up) brings on-line our patented Dyna-Watt™ Class AB Pentode style wiring for the full power and headroom. This setting is preferred for pristine clean sounds and tight-tracking high gain sounds as it delivers a burst of power and headroom far beyond the expectation of its rated power. This ingenious and unique MESA circuit stores up voltage in the power section and releases it at the instant of attack—when you need it most—then instantaneously sags down to a more “normal” voltage at a time-specific rate. Then it recovers in time to do it all over again for the attack of your next note or chord. This instant burst, sag and re-charge translates into a bouncy, dynamic sound and an amazing, precise, yet elastic feel on the strings. Pure tube magic!

The **10W** position (switch down) rewires the EL84 output tubes to Class AB Triode style wiring for a more vintage-voiced and oh-so-clip-able low power character. This produces less output, a smoother voice that clips with softer attack characteristics and a creamier feel.

This once-patented, now exclusive MESA circuit has been appreciated by players around the world for decades and has furthered the reputation that Boogie’s were the “little amp that could” since its introduction in the now-classic Studio 22 Combo back in 1984. Now combined with the incredible versatility of the MARK FIVE: 25’s two Channel preamp and 6 distinctive Modes, that reputation is safe and secure for future generations to enjoy.

POWER

This toggle switch delivers the A.C. power to the MARK FIVE: 25. Make sure the amplifier is grounded (all three terminals of the A.C. power cord connected) to avoid injury to the user as well as to the amplifier. Also make sure the proper voltage (117–125 Volts AC Domestic US Model) is present at the wall socket.

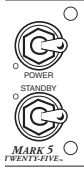

Always follow the Cold Start Procedure described in the STANDBY section when powering up your amplifier. This will reduce the likelihood of tube problems and increase their musical life.

STANDBY

Perfect for set breaks...this toggle switch also serves an even more important purpose. From Cold-Start, the STANDBY position allows you to warm up the tubes—especially power tubes— before applying the high voltage to them by switching the Standby to the “ON” position. Before POWER is switched to “ON” - make sure the STANDBY switch is set in the “STANDBY” position.

Cold-Start Procedure:

Flip the POWER SWITCH to ON, then wait at least 30 seconds for the tube filaments to warm up and then flip the STANDBY switch to the ON position. This prevents the shock of high voltage hitting cold tubes and reduces the likelihood of tube problems and increases their toneful life substantially.

NOTE: *This Cold Start Procedure is an important part of ensuring maximum tube life and reliability. Like a light bulb, the most wear occurs in the instant (short period, first few seconds) voltage is first applied. Like a light bulb, if a dimmer is used to reduce the voltage for the first few seconds or so of use, increased longevity is the result. The STANDBY is the amp's equivalent to a dimmer and using it in the above described method will ensure the longest life and best performance from a set of tubes (especially Output tubes).*

That covers the Inputs, Channels, Modes and Controls found on the Front Panel of the MARK FIVE: 25, now let's swing around to the Rear Panel and take a look at the Outputs, Features and Controls located there.

REAR PANEL



MAIN FUSE

This is the A.C. (Alternating Current) Main Fuse and it provides amplifier circuit protection from possible power tube failures as well as from A.C. voltage fluctuations. ALWAYS replace a blown fuse with one of the specific rating and type as (conveniently) printed on the back of your amplifier right next to the fuse holder. NEVER INSTALL A FUSE OF A HIGHER RATING than the value printed on the back of your amplifier. Doing so will very likely produce damage well beyond the original reason your fuse blew in the first place. Domestic USA Models of the MARK FIVE: 25 use a 1.25 Amp SLO-BLO type Fuse.

A power tube short or failure is often the cause of a blown fuse. Position yourself behind the amplifier and follow the Cold Start Procedure described in the STANDBY switch section of this Operating Guide. Watch the power tubes as you flip the STANDBY to the ON position. If a power tube is going bad or is arcing you will often see it flash as you flip the STANDBY and power up! Flip the STANDBY switch to "STANDBY" immediately and replace the faulty power tube (and the fuse as necessary).

If you see nothing abnormal as you move the STANDBY switch to ON, it is possible that a power tube shorted 'temporarily' and caused the blown Fuse. Occasionally, whether from just luck or from cooling down, a short in a power tube 'reconnects' itself temporarily and can operate normally again for a time... but this tube should be considered faulty and replaced as soon as possible to ensure uninterrupted performance. If you can identify a tube that is arcing or shorting by the method mentioned above and the tubes have minimal use, consider replacing the obviously faulty or failed tube and leaving the others installed.

If you haven't changed tubes for a while after heavier use, a failure may be telling you it's time to change all your power tubes. Save any working but used tubes as spares.

Spare fuses (of the proper type and rating) are a must for the fabled cord bag along with at least one set of spare tubes. Always have both on hand—at the gig or at home—since tubes decide, not you, when it's time to stop working. Spare tubes and fuses can be worth their weight in gold should you ever experience a tube failure, especially on a gig. We STRONGLY recommend making them a permanent fixture in your gig bag.

AC MAINS SOCKET (QUICK DISCONNECT STYLE)

This is the AC MAINS Power Cord Socket. The standardized removable power cable supplied with your amp can only be plugged in one way. Always connect the male end to a grounded (3-Hole) wall socket with the proper voltage present (117 Volts on U.S.A. Models). To Avoid The Risk Of Shock, Never Alter The Power Cable in any way. Altering the Power Cable will void your warranty and put you at risk while leaving your amplifier open to the possibility of damage.

FX (LOOP – SERIES)

The MARK FIVE: 25 benefits from 40 years of high performance amp design and the FX Loop featured here is a result of that experience and expertise. The FX Loop is wired in Series with the dry signal and as long as you are using processors of good quality, you should experience seamless interfacing with no tonal degradation. That said, anything you insert in this extremely sensitive junction of an amplifier (between preamp and power section) may have the potential to slightly alter the sound.

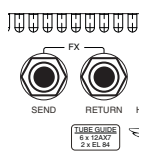

Also, every company that builds processors has their own way of doing things and there are circuits, controls and features that empower, and some that make things more complicated while adding questionable sonic benefit. We suggest taking your amp and trying it with the processor you are considering to make sure you will have great performance when they are coupled.

To connect your outboard processor(s) to the FX Loop:

1. Connect the SEND jack on the MARK FIVE: 25 Rear Panel to your processor's INPUT using a high quality shielded cable of the shortest possible length.
2. Connect the RETURN jack of the MARK FIVE: 25 to your (last) processor's OUTPUT also using a high quality shielded cable of the shortest possible length.
3. Adjust the processor(s) Output level stage (hopefully your processor has an OUTPUT LEVEL control) to match the volume present before connecting the device(s) to the Adjust the processor Output level stage (hopefully your processor has an OUTPUT LEVEL control) to match the volume present before connecting the device(s) to the MARK FIVE: 25 FX LOOP. You can check this by simply removing both the cables from the SEND and RETURN simultaneously.
4. Use the Front Panel MASTER control to raise and lower the overall volume as it is essentially an FX Return Stage volume control.

NOTE: It is normal to experience some amount of change to the sound when using the FX Loop. Normally this is minimal and most often appears as a subtle roll off in top end characteristics. This is a Series Loop and therefore the results you get using it greatly depend upon the quality of the devices you insert into the Loop. We strongly suggest taking your amplifier and trying any processor before buying it to make sure it is compatible with the MARK FIVE: 25. Normally, the more professional series lines of most companies building outboard gear work well. However we have seen even so called "pro gear" produce less than satisfactory results in terms of tonal thievery.

NOTE: The FX Loop uses switching-type jacks to engage the Loop circuitry. Removing the SEND and RETURN cables from the FX Loop jacks bypasses the FX Loop. While most pedal-type effects will work in the Loop, it is always best to connect Overdrive, Distortion, Boost, Compression and Wah or Envelope Filter effects between the Instrument and the Front End of the amplifier (INPUT). These effects are designed to alter the sound of the instrument before it is amplified, and you will get better results not using the FX Loop for these applications.

HEADPHONE

The MARK FIVE: 25 features a HEADPHONE Output for personal enjoyment of the amplifier when it is not possible—or you don't want to—play through a speaker. This stereo ¼" jack derives its "speaker simulated" signal from the on-board CABCLONE™ D.I. feature circuitry and delivers a surprisingly good rendering of the FIVE: 25's sound and feel to your headphone set of choice.



The CABCLONE circuitry is able to produce this great representation of the amplifier's sound because it starts with a signal taken right off the SPEAKER OUTPUT. This means you have the entire amp—including the output tubes—impacting all the Tone, nuance, natural tube compression and bouncy feel you are used to hearing through your cabinet.

Granted, the speaker cabinet shapes a lot of what you hear when playing your amp live, but the CABCLONE circuitry does an impressive job of retaining much of the experience of playing live through a cabinet and in trade, allows you to skip the hours and sometimes frustrating chore of mic-ing up your rig. One cable and you're up and running. And the fact that you get this good sounding HEADPHONE Output for personal practicing anytime is a real bonus.

The volume of the HEADPHONE Output is determined by the Channel MASTER controls (and the MULTI-WATT Power Setting) and you will need to adjust the HEADPHONES volume there as this circuit is passive and therefore has no op-amp driven volume control. NOTE: Headphones can vary greatly in both sound and efficiency (volume) and therefore the performance of the HEADPHONE jack can be optimized or compromised by the headphones connected to it. We recommend trying a few sets of different types and manufacturers with the MARK FIVE: 25 before choosing headphones for this application.

NOTE: Headphones and their proximity to your ears are vastly different from that of your favorite speaker cabinet, therefore, it is important to note that the settings of your amplifier will more than likely require adjustment to get the best results to match the inherent qualities of your headphones.

NOTE: Introducing a bit of internal REVERB into the mix or even an outboard processor into the FX Loop set to a Delay Preset can help the HEADPHONE Output sound more alive and natural, as it helps compensate for the air and “expansion” present when using a speaker cabinet in a live room.

The MARK FIVE: 25 is the first, but probably not the last, MESA amplifier to include the CABCLONE D.I. circuitry and associated HEADPHONE Output. This comprehensive direct recording and private monitoring feature greatly enhances the value, versatility and convenience of the amplifier and will provide you with new options for quick, hassle-free, direct recording options as well as late night (or any time) personal enjoyment of the FIVE: 25’s inspiring sound and feel.

NOTE: Plugging into the HEADPHONES jack defeats the CABCLONE D.I. XLR BALANCED Output. It is not possible to use the HEADPHONE and D.I. OUT simultaneously as the headphones would load down the circuitry further and compromise the sound.

NOTE: As there is no HEADPHONE Volume Control in the CABCLONE™ passive circuit, you will need to use the Channel MASTER Controls and the MULTI-WATT™ Power Select switches to determine the volume of the HEADPHONE output.

REVERB The MARK FIVE: 25 features independent Channel Mix Level controls for the analog, tube-driven, 3-spring Reverb. Different types of sounds call for different saturation (blend) levels and this independent control allows you to perfectly tailor the REVERB effect to the sound style you have dedicated each of the Channels to. These Mix Controls provide anything from a subtle ambient effect, to a fully drenched, deep Reverb sound, and anywhere in between.



Generally speaking, lower gain Clean sounds are the traditional place for more drenched Reverb Mix levels. Low, medium or higher gain single note sounds can also benefit from “wetter”, deeper Reverb blends, where it can add more “dimension” and width to your soloing. Higher gain Crunch rhythm sounds usually call for little to no Reverb, as these sounds are often used to play staccato parts with quick attack and cut-off characteristics and an abundance of Reverb will negatively affect the “perceived tracking”. However, there is no rule when it comes to music and we encourage you to play with any amount of Reverb you feel appropriate for your individual needs.

The Controls are laid out such that when reaching over the top of the amplifier, Channel 1’s REVERB Mix control is on the Left and Channel 2’s REVERB Mix control is on the Right. This layout was the result of many players feeling this was the best setup for trouble free adjustment of the REVERB levels from the Front of the amplifier when there is no room for Front-mounted controls.

SPEAKERS Two 4 Ohm and one 8 Ohm SPEAKER Outputs are provided for interfacing the MARK FIVE: 25 to your cabinet of choice. Most MESA/Boogie cabinets are built wired Standard to 8 Ohms unless Custom Ordered (or modified by an outside party, example; a previously owned cabinet). One 8 Ohm cabinet should be connected to the 8 Ohm output. When using two 8 Ohm MESA cabinets, connect one cabinet to the 4 Ohm output and “daisy chain” the second cabinet by coming out of the first cabinet’s PARALLEL Out jack into the second cabinet’s INPUT jack (MESA cabinets provide a Parallel jack for this purpose). If using two older 8 Ohm MESA cabinets (or two 8 Ohm cabinets by another manufacturer) connect each 8 Ohm cabinet to one of the 4 Ohm SPEAKER Outputs. This will provide the best impedance match and ensure optimum performance. If you have one 4 Ohm cabinet, connect it to the 4 Ohm

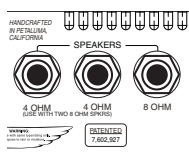

SPEAKER Output. This will be a proper impedance match, but you may experience a slightly softer attack characteristic than you would using a single 8 Ohm Cabinet.

If you are using non-MESA cabinets with your FIVE: 25, it is very important to know your cabinet’s impedance and make sure you are connecting speakers correctly and safely to the amp. Failure to connect speakers correctly can shorten tube life, put undue stress on the output transformer and possibly even damage it. Damage caused by improper impedance matching is not covered under the Warranty. ALWAYS make sure to connect your cabinet correctly to the SPEAKER Outputs on the amplifier. Check out the information later in this manual regarding speaker impedance and speaker hook-up schemes. No matter how unusual your speaker setup, it is usually possible to get optimum, safe performance through various speaker wiring techniques.

NOTE: We prefer an 8 Ohm Cabinet (Impedance) Load whenever possible and feel it provides the optimum impedance matching and delivers the best performance. Other impedance Load scenarios work, but we feel the best combination of power (headroom), bold

attack, sweet sparkling top end, and tight-tracking low end are achieved with an 8 Ohm Cabinet Load.

NOTE: Repeated From HELPFUL HINTS Section; Speaker Impedance has a sonic effect on the sounds of the MARK FIVE: 25 power section (and when it is switched between its two different Modes). We prefer a matching 8 Ohm Speaker Load connected to the 8 Ohm SPEAKER OUTPUT for the most balanced sound and overall performance. You can safely experiment with different Load combinations in the high direction, for example an 8 Ohm Speaker Cabinet connected to the 4 Ohm SPEAKER OUTPUT jack on the MARK FIVE: 25, or a 16 Ohm Cabinet on the 8 Ohm SPEAKER OUTPUT. You can't hurt your amplifier loading it in the high direction and you may discover an impedance scenario that, though a technical "mismatch", produces a unique response that fits your needs. The only penalty might be that your power tubes may wear a bit faster with mismatched load conditions and you won't achieve the amplifier's maximum headroom (full power output). Do Not use an impedance mismatch in the low direction (example: a 2 Ohm Load on a 4 Ohm SPEAKER Output) as this is very hard on the Output transformer and may cause damage to the amplifier.

CabClone™ D.I.

As mentioned in the OVERVIEW in the Front of this Manual, the MARK FIVE: 25 features one of—if not the—coolest feature ever to grace a MESA Rear Panel, the on-board CABCLONE D.I. and Cabinet Simulation feature. This built-in direct recording solution allows you to capture a wonderful representation of the MARK FIVE: 25's inspiring sound and feel direct to a Console, Converter or even direct to a Recorder without the need to mic up a speaker. Impossible you say, a long list of well known producer's, engineers and player's would beg to differ with you.

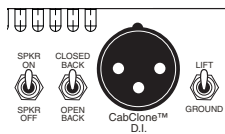

Taken directly from our acclaimed stand-alone CABCLONE™ D.I. unit, this speaker-compensated D.I. XLR Balanced Output (and HEADPHONE Output) does an incredible job of capturing the signal from the SPEAKER OUTPUT and turning it into direct- injection gold. The four elements here in this section of the Rear Panel allow for use with a live speaker or without, so you can blend the direct signal and a mic'd speaker cabinet

if you so desire.

The CABCLONE section features include:

- **SPKR ON/SPKR OFF** - SPEAKER Status
- **CLOSED BACK/OPEN BACK** - CABINET Style
- **CabClone™ D.I.** - XLR BALANCED D.I. Output
- **LIFT/GROUND** - Pin 1 Float .

This array of controls and Output comprises perhaps one of the most valuable and welcome feature set on any MESA amp, expanding both the functionality and enjoyment potential many fold. The MARK FIVE: 25 is the first of our amplifiers to include this powerful tool built right in for speedy and convenient recording applications without sacrificing authenticity and Tone. It's sure to increase the professional potential of this little dynamo and help this compact MARK Series package usher in a new era of MESA performance as well as raise the bar even further for amplifiers in its category and beyond.

SPKR ON/SPKR OFF

This mini toggle mutes the SPEAKER Output when you want to record "silently" with the CabClone D.I. (direct with no speaker sound from the amplifier). This switch allows you to decide if you'd like to utilize both a live speaker cabinet AND the CabClone's XLR Direct Out or just the XLR D.I. OUT. Also, while it's not needed as you have the STANDBY on the Front Panel for this purpose, this switch may be used as a Mute switch, though with its Rear Panel location this is a less desirable way to achieve that function.

NOTE: IMPORTANT! The SPKR OFF switch position automatically connects a Load Resistor to the SPEAKER Outputs to prevent damage to the output transformer and allow silent (no cabinet connected) direct recording with the XLR D.I. OUT. Selecting SPKR ON defeats the internal Load and connects the signal to the SPEAKER Outputs. DO NOT USE THE AMPLIFIER IN THE SPKR ON SWITCH POSITION WITHOUT A CABINET (LOAD) CONNECTED! Damage to the amplifier will likely occur and is not covered under the Warranty!

NOTE: REMINDER! If you have everything ON... POWER, STANDBY, GAIN and MASTER (as well as Input and Output Volume Controls on any Effects in the FX Loop) and get no sound; Check the SPKR OFF/SPKR ON switch in the CabClone™ Section at the far Right of the Rear Panel (when looking at the back of the amplifier) to make sure the toggle switch is set to SPKR ON. This may have been bumped during shipping, transport or set up.

CLOSED BACK/OPEN BACK The on-board CabClone™ D.I. feature offers two classic “cabinet simulated” voicing options created from our 45 years of experience co-designing custom speakers with the world’s top makers and designing speaker cabinets to load them in. These CabClone “virtual-cabinet” options allow you to tailor the direct circuit’s EQ response for different cabinet styles, gain regions and/or different instruments and pickups. The choices range from bright and open with enhanced top end that buffs clean sounds (OPEN BACK), to a more compressed voice with the upper harmonics shelved for warm, singing single note sounds and thick high gain rhythm work (CLOSED BACK).

Because clean and overdriven sounds really need these different cabinet types to sound authentic, you will need to experiment with the two voicing options with your range of sounds for increased accuracy when employing the CabClone for direct recording. The lower OPEN BACK position takes the lid off the top end so the upper harmonics can shine through and provide a more open, three-dimensional sound with accentuated brightness. This position works well for clean work and overdriven rhythm applications where a brighter, “faster”, more urgent response is in order.

The upper CLOSED BACK position rolls off top end and compresses the sound in comparison to its “open sounding” counterpart and this focuses higher gain sounds and removes unwanted spurious artifacts and “buzz”. This position mimics the steep roll-off that occurs in the best guitar speakers, which few realize is a HUGE part of why overdrive and distortion sounds are often reproduced in a musical way in these classic drivers. Without this steep roll-off, overdriven guitar sounds are pretty thin, buzzy and separated, and we’ve all become accustomed to this speaker effect as a natural part of a good overdrive sound. If you’ve ever experienced a guitar amp that had any gain dialed up through hi-fi speakers, or even a Direct output without “speaker compensation”, you know how important this roll-off is to TONE!

When blending a live cabinet mic’d and the CabClone direct, you can also try selecting the Cabinet Voicing option that has an opposite (or different) response to that of the cabinet you are mic-ing for a blend-able “opposing difference” later when mixing.

Within these two selectable Cabinet Style Voicing Options, you’ll find the ability to tune the CabClone D.I.’s response to work well for almost any sound style. Keep in mind that adding the live speaker may affect the sound of these VOICING choices... making things more reactive dynamically and perhaps brighter as well, depending on the speaker’s (and cabinet’s) inherent characteristics that you have chosen.

NOTE: Remember that the CabClone circuit gets its feed from the SPEAKER Output and whatever cabinet (Load) you are using “reflects backwards” and has an effect on the characteristics (both in regards to dynamics and frequency response) of the amplifier’s power section.

CabClone™ D.I. This male 3-pin XLR Output provides a balanced signal for direct interface to a Console, Preamp or Recorder. Use a standard 3-Pin XLR mic cable (of any reasonable length) to connect to your direct interface destination of choice. Next choose whether you wish to record with the CabClone speaker compensated signal alone, or whether you wish to blend a live speaker cabinet with this Direct signal using the SPKR OFF/SPKR ON mini toggle to the left.

As the CabClone circuit is passive, there is no dedicated Output Level Control, so the Channel MASTERS and the MULTI-WATT Power Select switches will determine your send level strength at the CabClone D.I. Output.

NOTE: It is a wise practice to get in the habit of beginning every Direct session with the MARK FIVE: 25’s Channel MASTER Controls set to “0” and the STANDBY switch set to “STANDBY”. This will help avoid unpleasant and/or embarrassing level surges through the Console and/or Playback Monitors should the Faders (INPUT Attenuator) be up already or set too high.

It is ALSO wise to “zero-out” the Console or Preamp/Recorder INPUT Trim to help avoid similar unpleasant surprises.

LIFT/GROUND

This switch allows you to lift the CABCLONE BALANCED D.I. Output's XLR jack (PIN 1) GROUND, from Circuit and Chassis GROUND and in many cases (but not all) remove hum caused by a ground loop. In silent recording environments every little noise stands out and ground loops can produce one of the more common (and annoying) sources of hum and/or buzz. It is not a cure-all to this common problem by any means, but it can often make a positive impact on the noise floor and at least help you rule out one common source of "hum".



That pretty much wraps up our tutorial of the MARK FIVE: 25's features. Now it's your turn to take this powerful tool into your musical world and put it to use exploring uncharted frontiers. We sincerely hope it takes you places you've never been and allows you to express in new and exciting ways. Learning it's Controls and Features will make you fluent in the language of TONE and enable you to roam wherever you feel inclined stylistically with confidence.

From all of us here at MESA/Boogie, welcome to the Family and we wish you many years of inspiration and enjoyment from your new instrument.

NOTES

FACTORY SAMPLE SETTINGS

FAT CLEAN / II-C+ LEAD

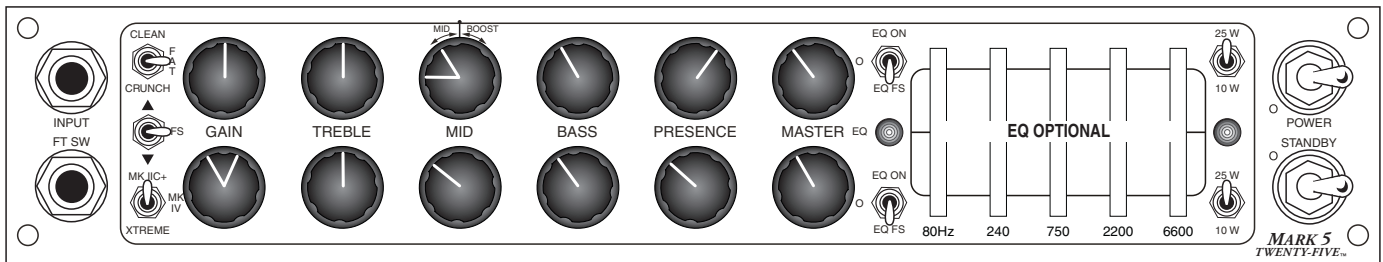

TIGHT CLIPPED / II-C+ BLUES LEAD

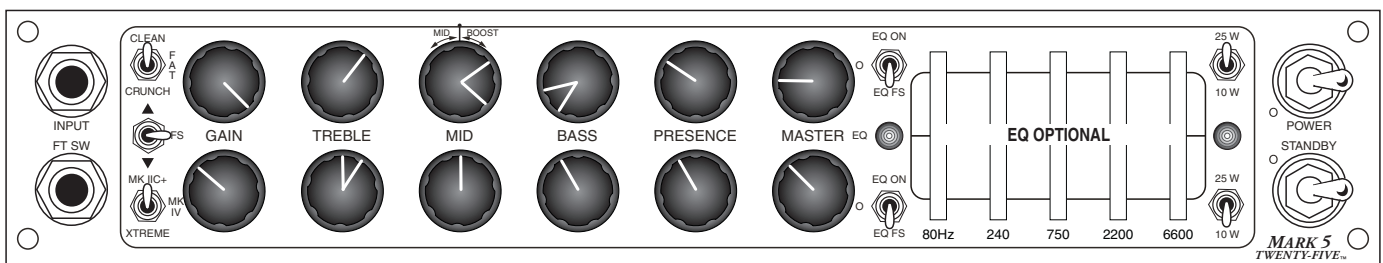

FAT CLIPPED CLEAN / MARK IV WARM BLUES

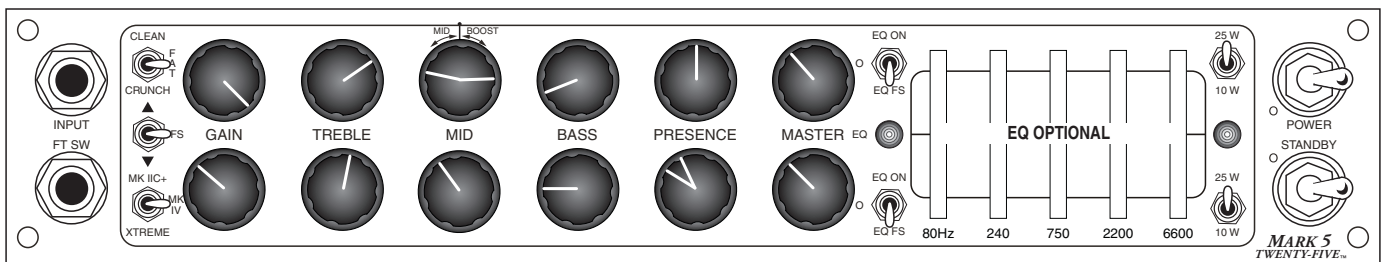

FAT SOLO / SKINNY II-C+ RHYTHM

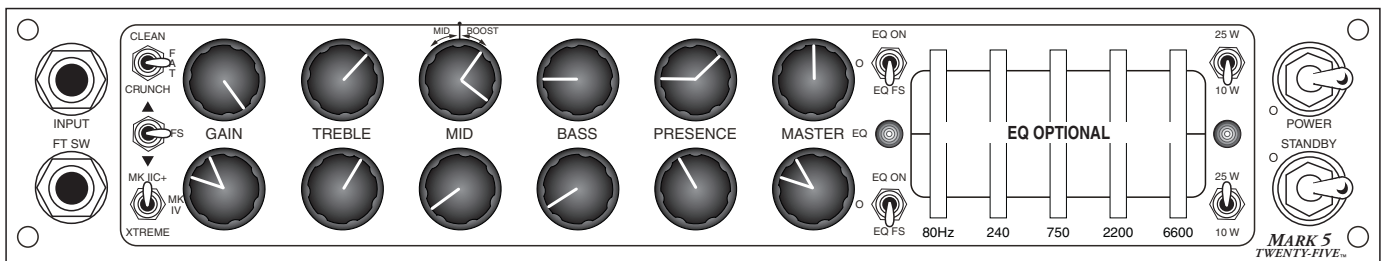

FACTORY SAMPLE SETTINGS

II-C+ CLEAN / II-C+ SOARING LEAD

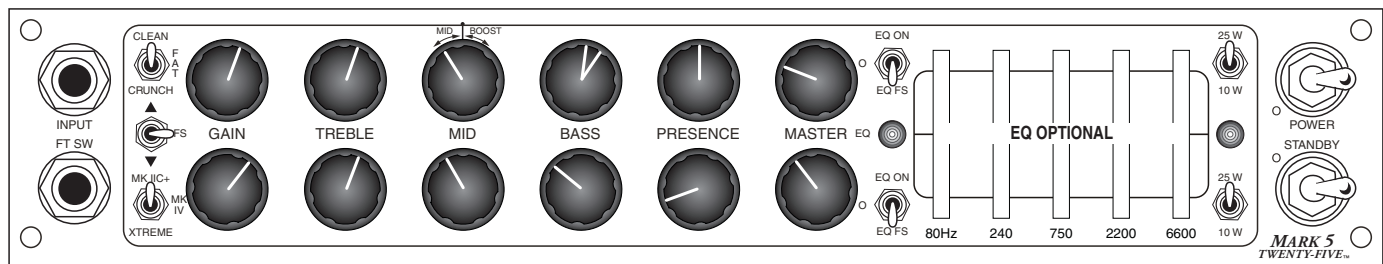

CRUNCH SOLO / MARK IV TIGHT RHYTHM

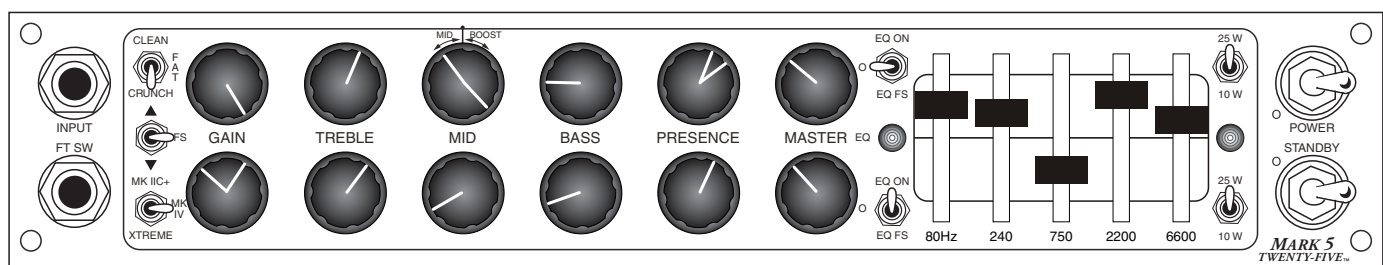

CRUNCH CLASSIC / II-C+ CLASSIC ROCK

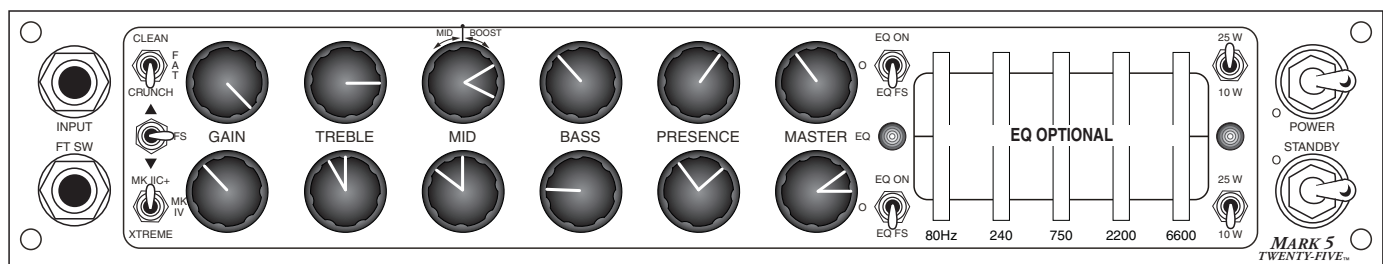

PUNCH RHYTHM / MID-BUMP LEAD

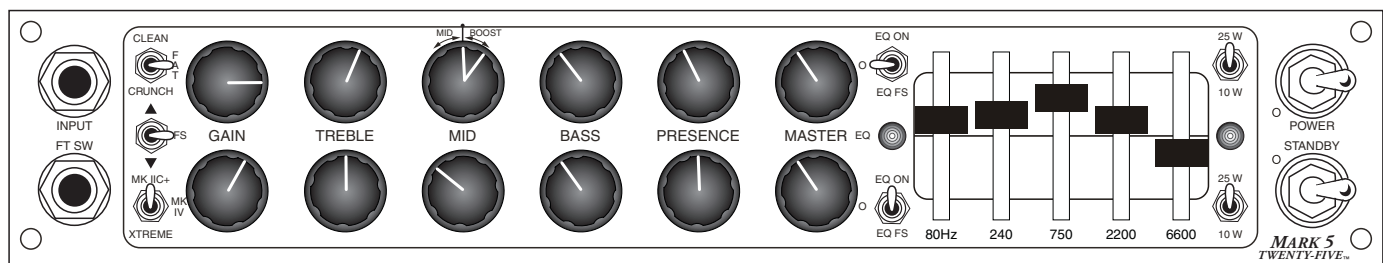

USER SETTINGS

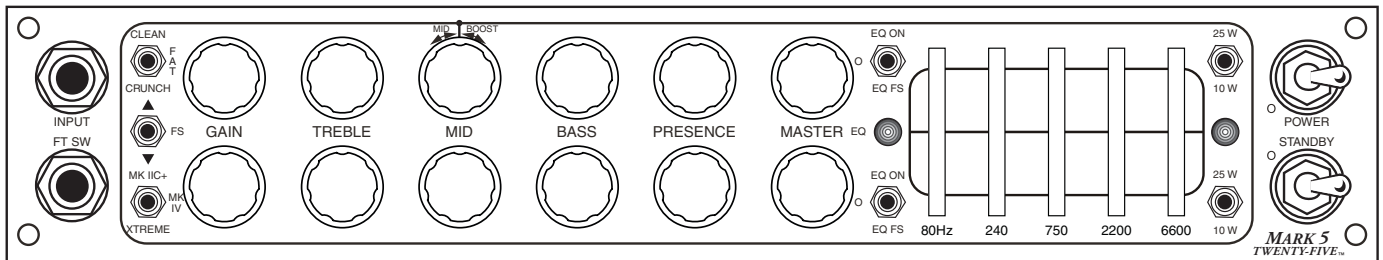
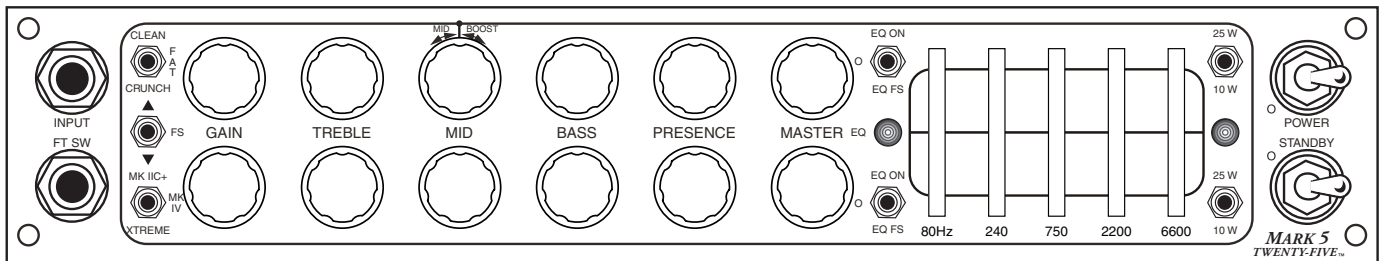
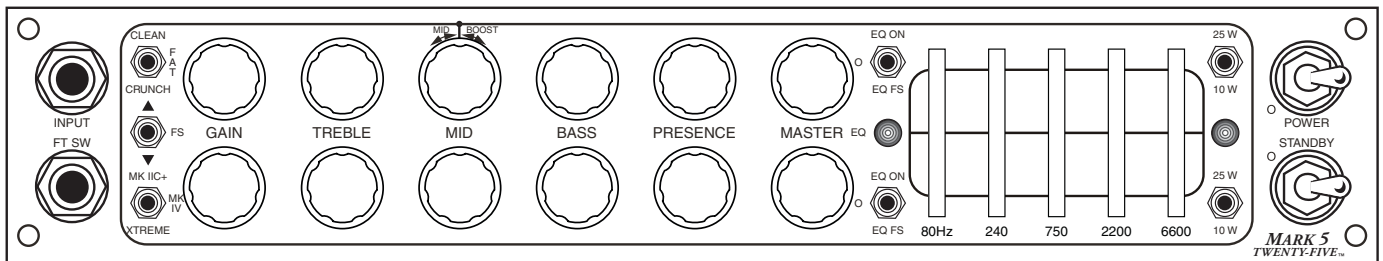
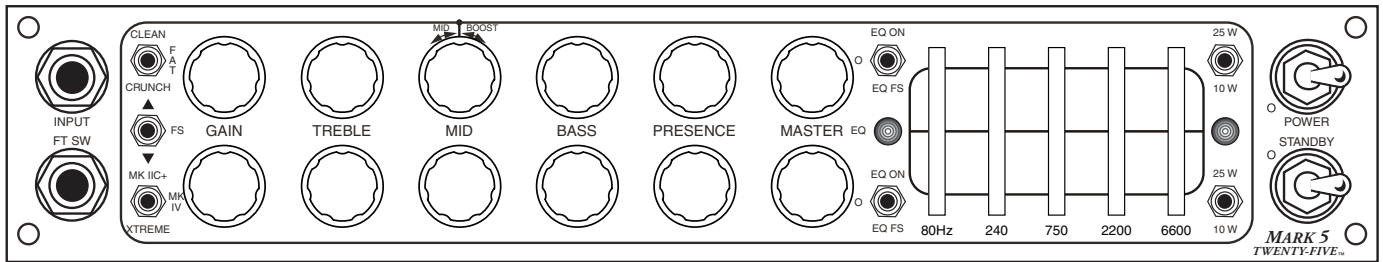

USER SETTINGS

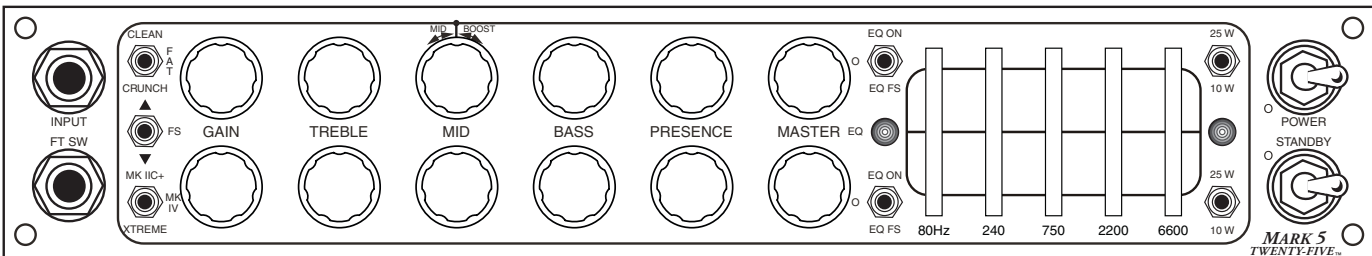
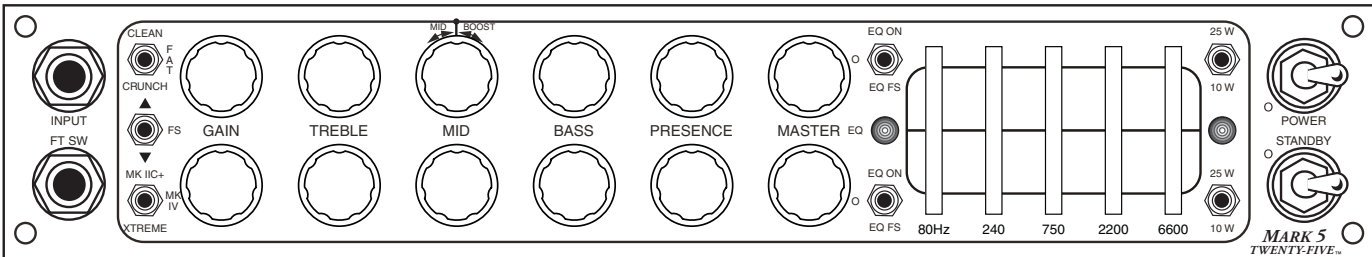
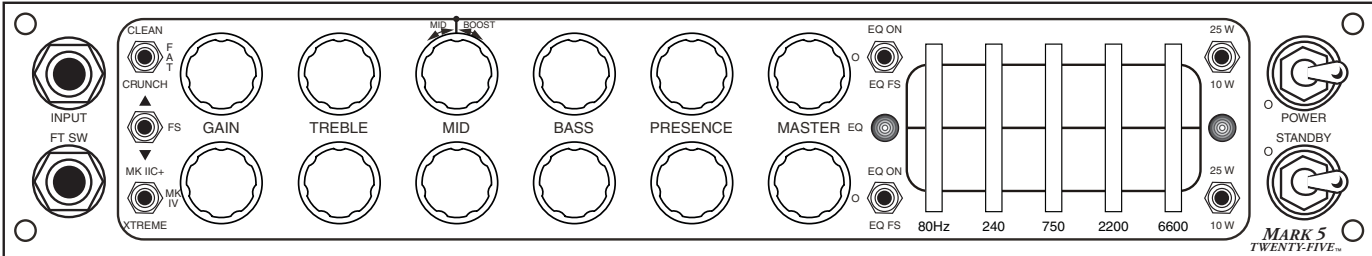
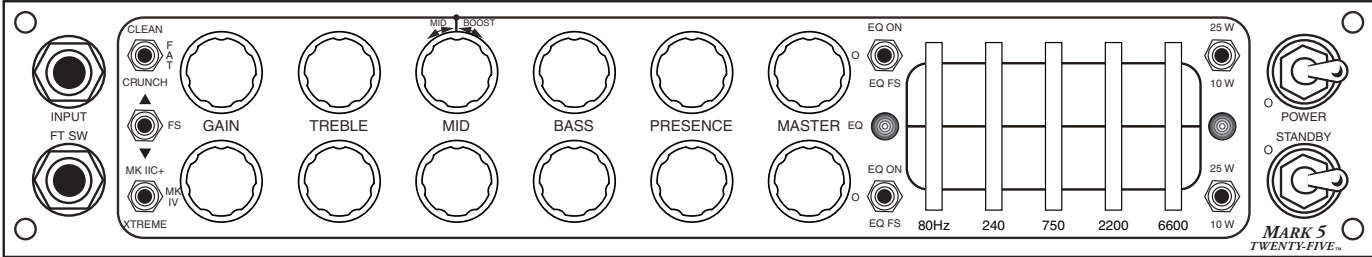

TUBE NOISE & MICROPHONICS:

You may occasionally experience some form of tube noise or microphonics. Certainly no cause for alarm, this quirky behavior comes with the territory and the Tone. Much like changing a light bulb, you don't need a technician to cure these types of minor user serviceable annoyances and in fact, you'll be amazed at how easy it is to cure tube problems...by simply swapping out a pre-amp or power tube!

First may we suggest that you set the amplifier up on something so that you can get to the tubes comfortably without having to bend down. It also helps to have adequate lighting as you will need to see the tube sockets clearly to swap tubes. **Use caution and common sense when touching the tubes after the amplifier has been on as they may be extremely hot!** If they are hot and you don't want to wait for them to cool off, try grasping them with a rag and also note that the glass down around the bulbous silvery tip is considerably less hot which makes it easier to handle. Gently rock the tube back and forth as you pull it away from its socket.

DIAGNOSING POWER TUBE FAILURE:

There are two main types of tube faults: shorts and noise. Both large and small tubes may fall prey to either of these problems but diagnosis and remedy is usually simple.

If a fuse blows, the problem is most likely a shorted power tube and shorts can either be mild or severe. In a mildly shorted tube the electron flow has overcome the control grid and excess current flows to the plate. You will usually hear the amp become distorted and begin to hum slightly. If this occurs, quickly look at the power tubes as you switch the amp to STANDBY and try to identify one as glowing red hot. It is likely that two of a pair will be glowing since the "shorted" tube will pull down the bias for its adjacent mates, but one tube may be glowing hotter — and that one is the culprit. The other two are often fine — unless they've been glowing bright red for several minutes.

Because there is no physical short inside the tube (just electrons rioting out of control) merely switching to STANDBY for a few moments then back to ON will usually cure the problem...at least temporarily. Watch the tubes carefully now. Should the problem recur, the intermittent tube will visibly start to over heat before the others and thus it can be identified. It should be replaced with one from the same color batch, shown on its label. Call us and we will send one out to you.

The severe short is not nearly so benign. In the worst cases, a major arcing short occurs between the plate and the cathode with visible lightning inside the glass and a major noise through the speaker. If this is seen to happen, IMMEDIATELY turn the amp to STANDBY. By this time the fuse probably will have blown. Such a short is usually caused by a physical breakdown inside the tube including contaminate coming loose or physical contact (or near contact) between the elements. Replace it and the fuse with the proper slo-blo type and power up the amp using the power up procedure as we described earlier in this manual.

TUBE NOISE:

Often caused by contamination within a tube, the culprit can usually be identified, and by lightly tapping on the glass, you will probably hear the noise change. Hearing some noise through the speakers while tapping on the 12AX7's is normal however. And the one nearer the INPUT will always sound louder because its output is being further amplified by the second 12AX7.

The power tubes should be all but quiet when they are tapped. If crackling or hissing changes with the tapping, you have probably found the problem. To confirm a noisy power tube, merely put the amplifier on Standby, remove it from its socket and turn it back on. It will cause no damage to run the amplifier briefly with one power tube missing. You may notice a slight background hum, however, as the push-pull becomes unbalanced. Whenever you are trying to diagnose a suspect tube, keep your other hand on the POWER and STANDBY switches ready to shut them off instantly in the unlikely case you provoke a major short.

If you think you've located a problem tube but aren't sure, we recommend substituting the suspect with a new one just to be sure of your diagnoses. You will be doing yourself and us a big favor by just following the simple guidelines previously mentioned regarding tube replacement. You'll probably be successful with much less effort than is required to disconnect everything and haul the unit to a technician who will basically perform the same simple tests. If the tubes are still within their six-month warranty period, we will happily send you a replacement. Just note the color designation on the tube label so that we can send you the appropriate match.

DIAGNOSING PRE-AMP TUBE PROBLEMS:

Because your amplifier is an all tube design, it is quite possible that you will at some point experience minor pre-amp tube noise. Rest assured - this is no cause for alarm and you can take care of the problem yourself in a matter of minutes by simply swapping tubes.

Let us begin by saying; It is a "very good" idea to keep at least a couple of spare pre-amp tubes on hand at all times to insure uninterrupted performance. These minor pre-amp tube problems can take many forms but can generally be described in two categories: Noise and Microphonics. Noise can be in the form of crackling, sputtering, white noise/hiss and/or hum. Microphonic problems usually appear in the form of a ringing or high pitched squealing that gets worse as the gain or volume is increased thus are more noticeable in the higher gain "HI" modes. Microphonic problems are easily identified because the problem is still present even with the instruments' volume off or unplugged altogether - unlike pick-up feedback which ceases as the instrument is turned down. Microphonic noise is caused by mechanical vibration and shock: think of banging a microphone around and you'll understand where the word came from.

The best way to approach a pre-amp tube problem is to see if it occurs only in one specific mode or channel. This should lead you to the tube needing replacement. Then all that remains is to swap the suspect tube for a known good performer. If you cannot narrow down the trouble to a specific mode or channel, the problem may be the small tube that drives the power tubes which is operational in all modes and channels. Though rare, a problem with the driver tube would show up in all aspects of performance - so if you can't narrow the problem down to being mode or channel specific, you may want to try replacing the driver tube. Driver problems generally show themselves in the form of crackling or hum in all modes of performance and/or weak overall output from the amplifier. Occasionally an anemic driver tube will cause the amplifier to sound flat and lifeless, but this is somewhat uncommon, as worn power tubes are a more likely suspect for this type of problem.

Sometimes making the diagnosis is more trouble than it's worth and it's faster and easier to merely replace the small pre-amp tubes ONE AT A TIME with a replacement known to be good. But MAKE SURE you keep returning the tubes to their original socket until you hit the one that cures the problem. You'll notice that tubes located nearer to the INPUT jack always sound noisier...but this is because they are at the start of the chain and their noise gets amplified over and over by the tubes that follow. The tube that goes into this "input socket" (usually labeled V1) needs to be the least noisy of the bunch. The tube that goes at the end of the preamp chain - just ahead of the power tubes - can be quite noisy without causing any problem at all. The tubes in your amp have already been located in the most appropriate sockets and this is why you should NEVER pull them all out at once and ALWAYS swap them one at a time. ALWAYS return a perfectly good tube to its original socket. Also it's a good idea to put the amp on STANDBY when swapping tubes to reduce the heat build up in the tubes themselves and to prevent explosive noises (which can still occur even if you are pulling the tubes away from their sockets gently) from coming through the speaker.

Remember, take your time, be patient and chances are real good that you can fix your amp yourself by finding and replacing the bad tube. It kills us to see someone who has shipped their amp back to us...and all it needed was a simple tube replacement! If you must send back your amp, remove the chassis from the cabinet by unscrewing the four mounting bolts on the bottom top. The chassis then slides back like a drawer and comes out from the back. Remove the big power tubes and mark them according to their location from left to right 1, 2 etc. They need to be wrapped separately with plenty of wadded up newspaper around them and put in a smaller box within the larger carton. Remove the Rectifier tubes and wrap them also. You can leave the preamp tubes in or remove them and wrap them separately being sure to label their location. (See Tube Task Chart.)

To wrap the chassis, use plenty of tightly wadded up newspaper so there is at least six inches of "crush space" between the chassis and the cardboard box. Bubble wrap also works well, but please DON'T use styrene peanuts - they will shift during transit and get lodged inside your electronics as well as allowing your amp to end up at the bottom of the box unprotected and possibly damaged.

Pre-amp tubes don't normally wear out as a rule. Therefore, it is not a good idea to change them just for the sake of changing them. If there isn't a problem - don't fix it. If there is no result from your substitutions, it may be possible that you have more than one problematic tube. Though rare, this does happen and though it makes the troubleshooting process a little more intimidating, it is still possible to cure the problem yourself.

NOTE: *It is normal to hear a slight metallic ringing sound when tapping on the preamp tubes. As long as the tube does not break into oscillation or start crackling or any other form of bizarre noise, it is considered normal and functional.*

SPEAKER IMPEDANCE MATCHING & HOOK-UP GUIDE:

IMPEDANCE: Wiring up speakers to provide the most effective load and making sure that all of them are in phase will help in creating the best sound possible. This is not too difficult, as long as you understand a few things about loading and how to connect your speakers to provide an optimal resistive load.

MESA/Boogie amplifiers can handle 4 and 8 ohms effectively. Never run below 4 ohms in a tube amplifier unless you are absolutely certain that the system can handle it properly; this can cause damage to the Output transformer. A few amplifiers can handle 2 ohms effectively without damaging them (for example the *MESA'S Bass 400+*). You can always have a higher resistance (16 ohms, for example) without damaging results, but too low of a resistance will likely cause problems.

MIS-MATCHING: When running a higher resistance (for example: 8 ohm output into 16 ohm cabinet), a slightly different feel and response will be eminent. A slight mismatch can provide a darker smoother tone with a little less output and attack. This response is a result of the amplifier running a bit cooler. Sometimes when using more than one cabinet a mismatch will be the only option.

WHAT IS MY CABINETS IMPEDANCE: If you have only a single speaker, you just match that single speakers impedance to the amplifier, and you are done. In many cases, you will have a number of speakers, and then you must calculate the "load" that the amplifier will need to support. There are generally three ways to wire multiple speakers together. They are as follows:

SERIES: When you wire (hook-up) speakers in Series, the speakers resistance (as measured in ohms) is additive - i.e. putting two 8 ohm speakers in Series results in a 16 ohm load.

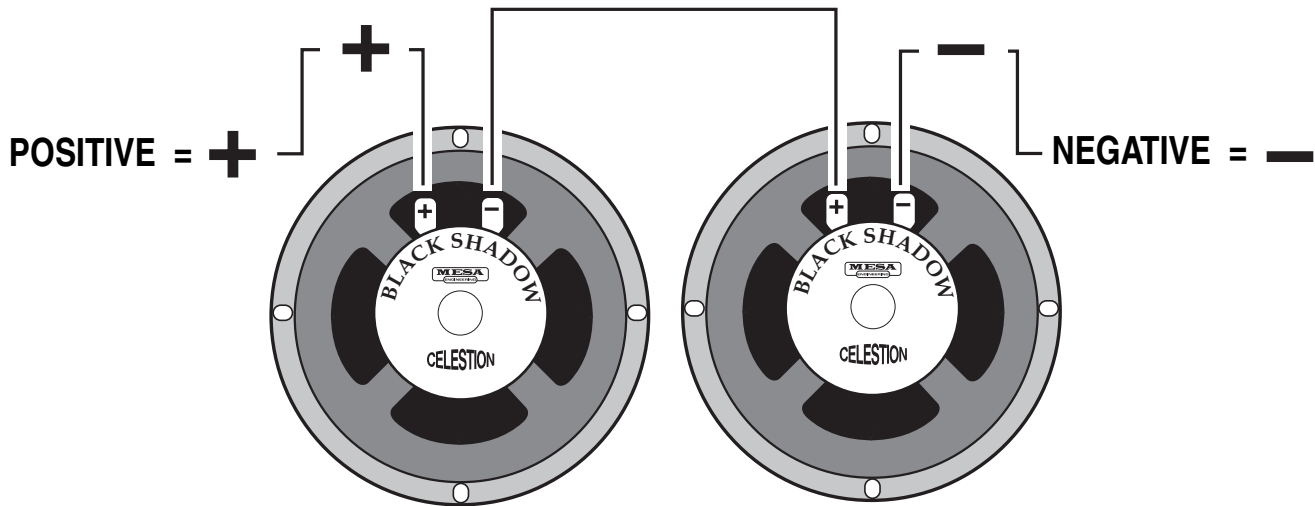

Speaker A = 8 Ohms

Speaker B = 8 Ohms

SERIES: Connect the Negative side of Speaker A
to the Positive side of Speaker B

SPEAKER IMPEDANCE MATCHING & HOOK-UP GUIDE: (Continued)

PARALLEL: When wiring in parallel, the resistance of the speakers decreases. Two 8 ohm speakers wired in (hooked-up) Parallel results in a 4 ohm load. It's easy to calculate the effect of a resistive load when all the speakers are all the same resistance. It is really not suggested to wire different resistive load values in Parallel (8 and 4, 16 and 8 etc.) The formula for figuring the total impedance in Parallel is the multiplication of the two loads divided by the sum of the two loads - i.e. putting two 8 ohm speakers in Parallel results in a 4 ohm load. Connect the Positive side of Speaker A to the Positive side of Speaker B - Connect the Negative side of Speaker A to the Negative side of Speaker B.

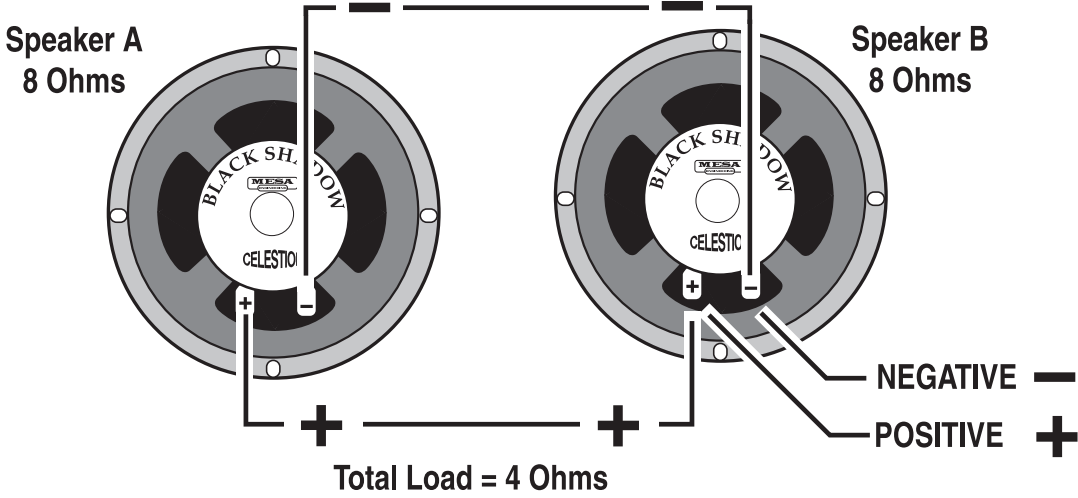

COMBINATION OF SERIES & PARALLEL: This is really just two sets of Series wired speakers connected in Parallel. This is how you maintain a consistent load with multiple speakers. The importance of this is more evident when you have more than one cabinet to connect to your amplifier. This is when you need to figure out the loads and how to wire them up without applying too low of a resistance on the amplifier.

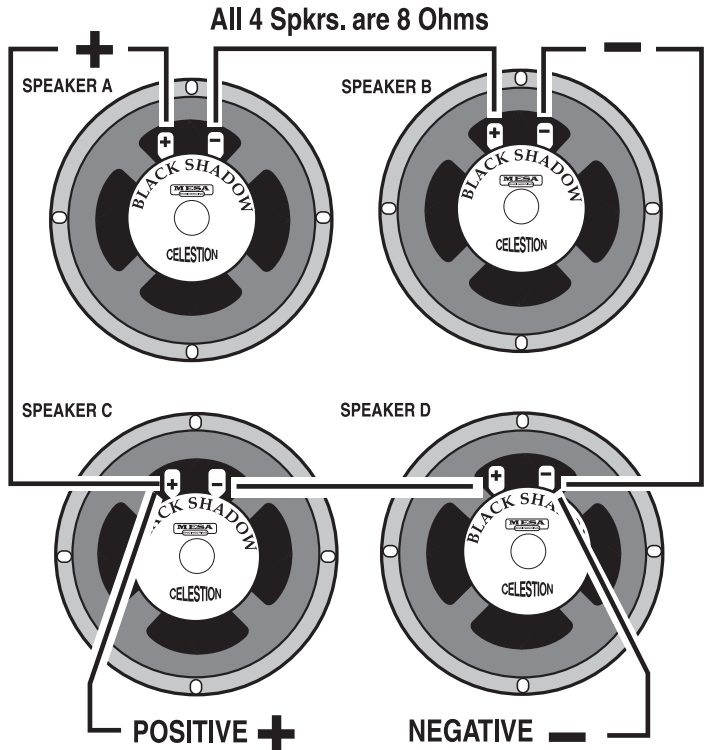

Simply connect the Positive side of Speaker A to the Positive side of Speaker C.

Connect the Negative side of Speaker A to the Positive side of Speaker B. Next, connect the Negative side of Speaker C to the Positive side of Speaker D.

And lastly, connect the Negative side of Speaker B to the Negative side of Speaker D.

4 Eight (8) Ohm speakers wired in Series Parallel = a Total Load of 8 Ohms.

WIRING SCHEMES...Amplifier to Speaker Cabinets

1

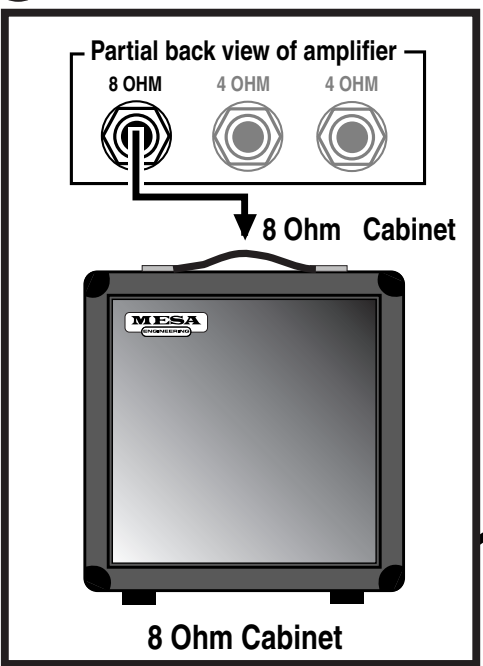

2

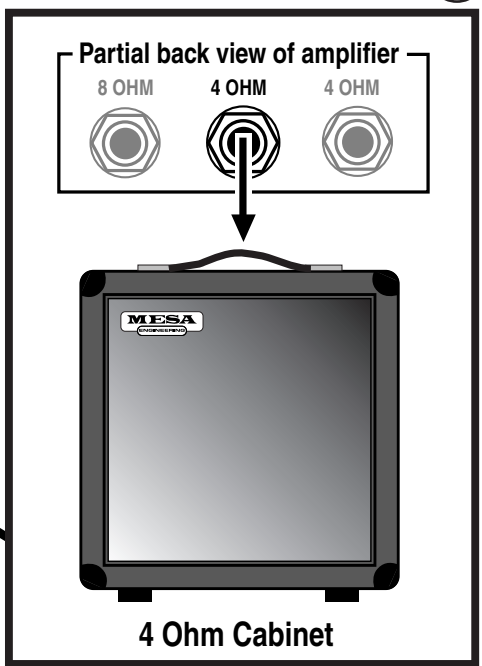

3



4

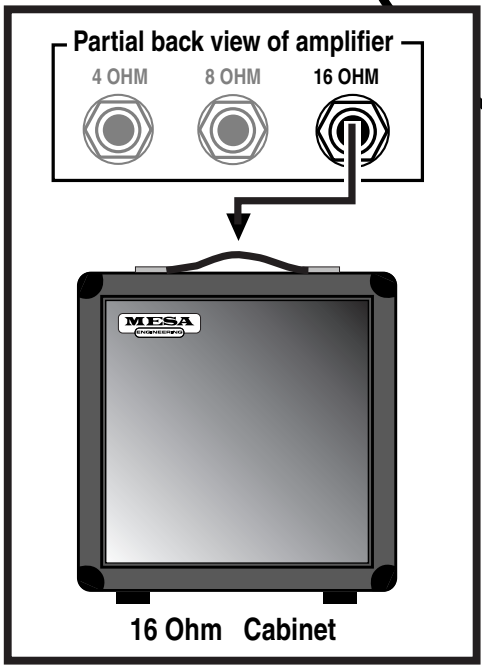

5

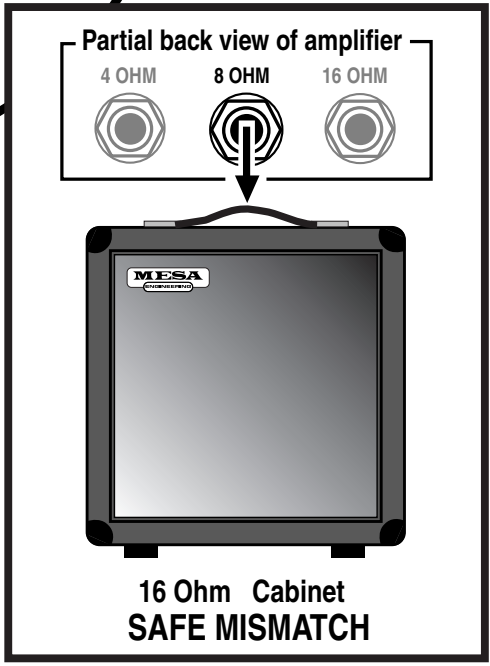

WIRING SCHEMES...Amplifier to Speaker Cabinets

6

7

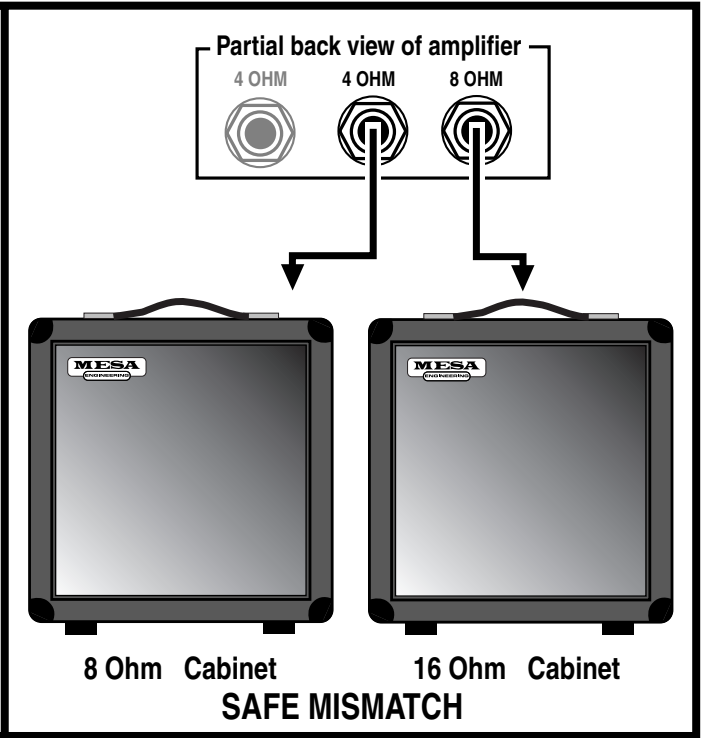
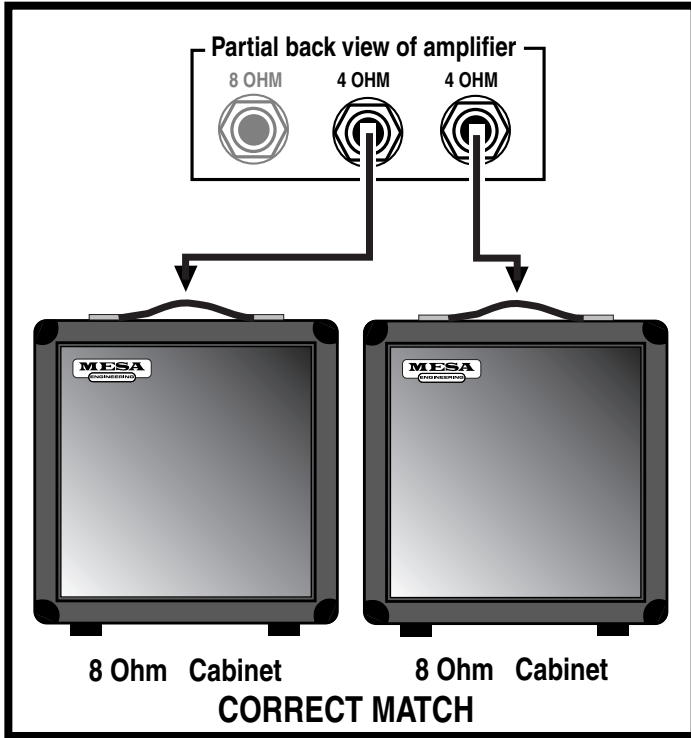

8

9

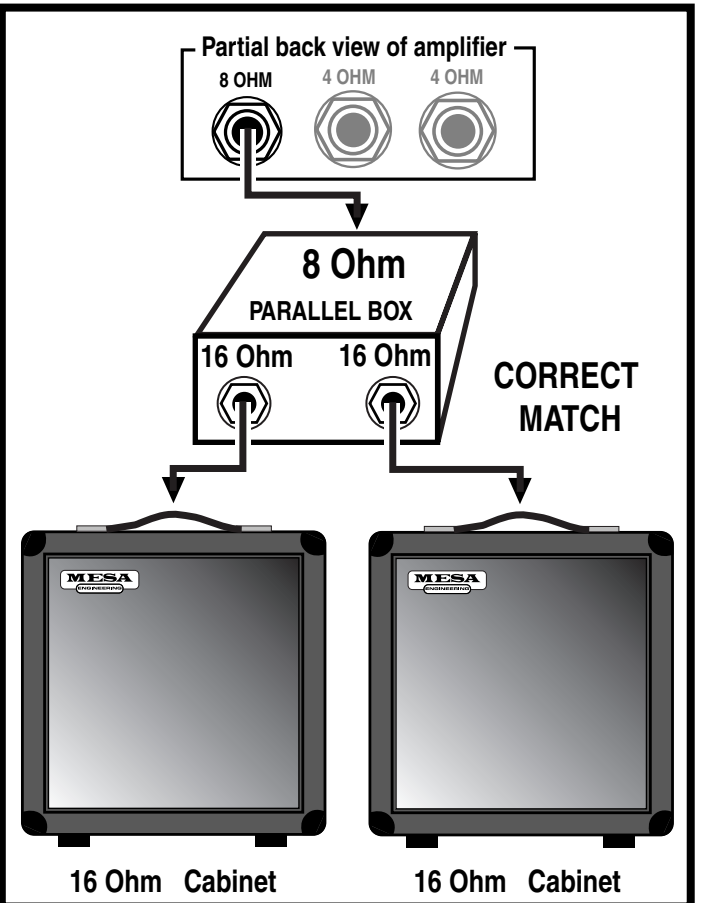
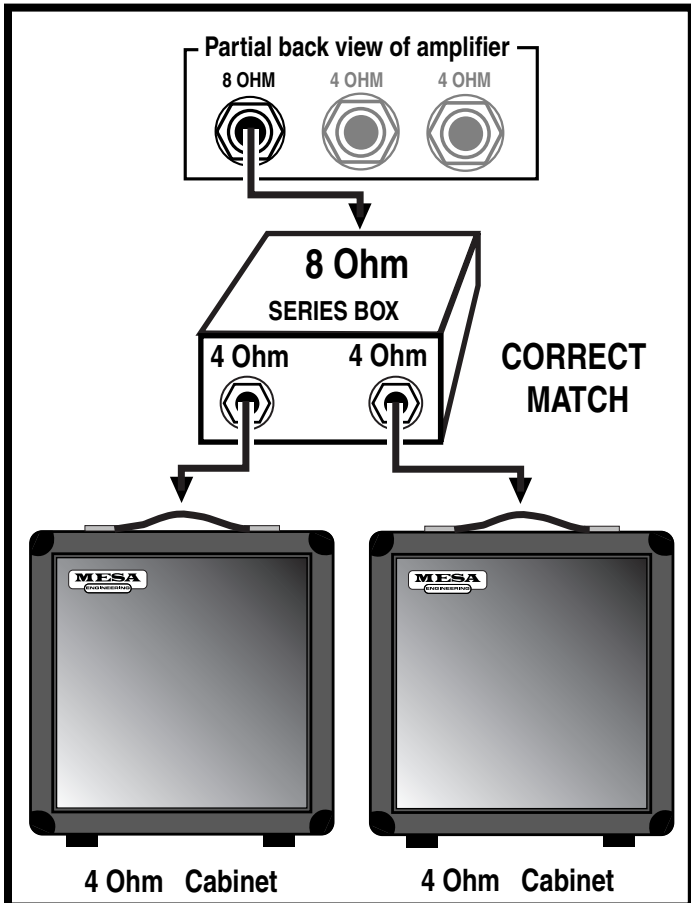

WIRING SCHEMES...Amplifier to Speaker Cabinets

10

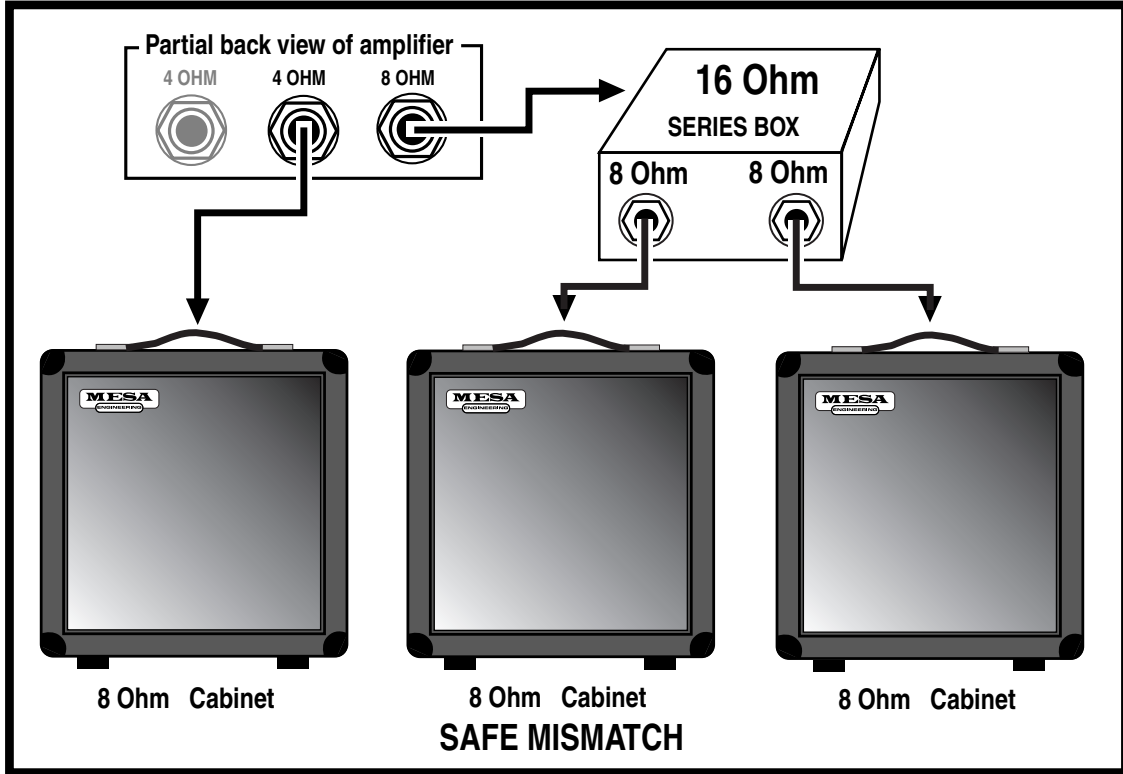

11

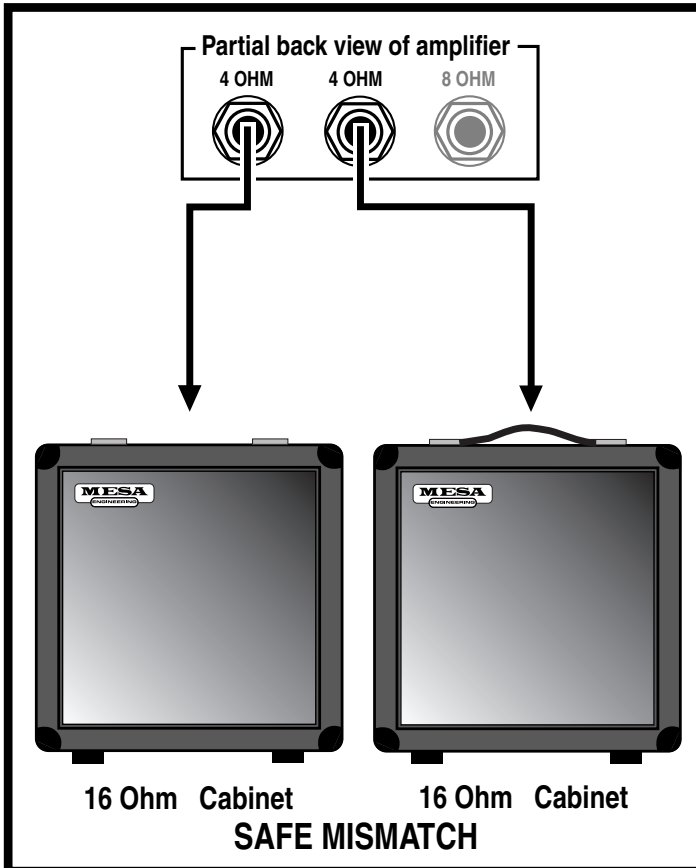

12

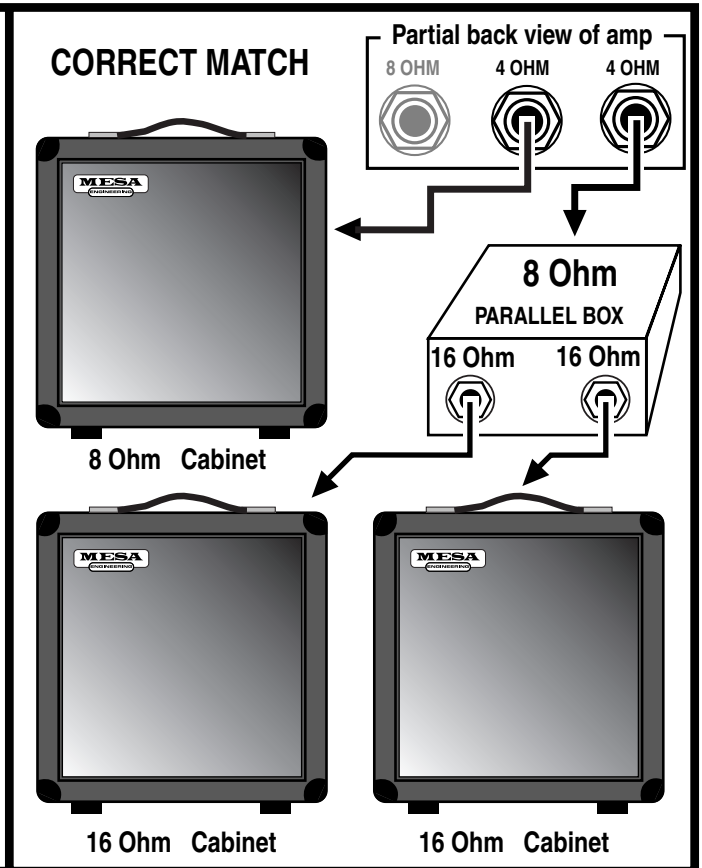

WIRING SCHEMES...Amplifier to Speaker Cabinets

13

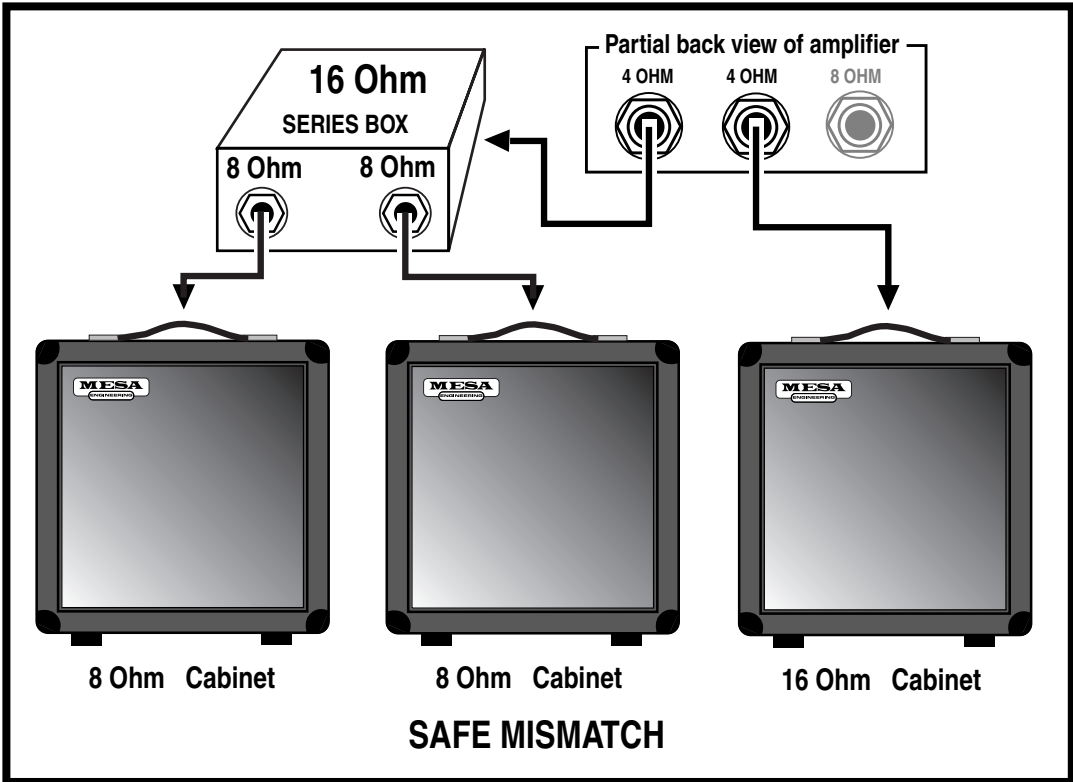

14

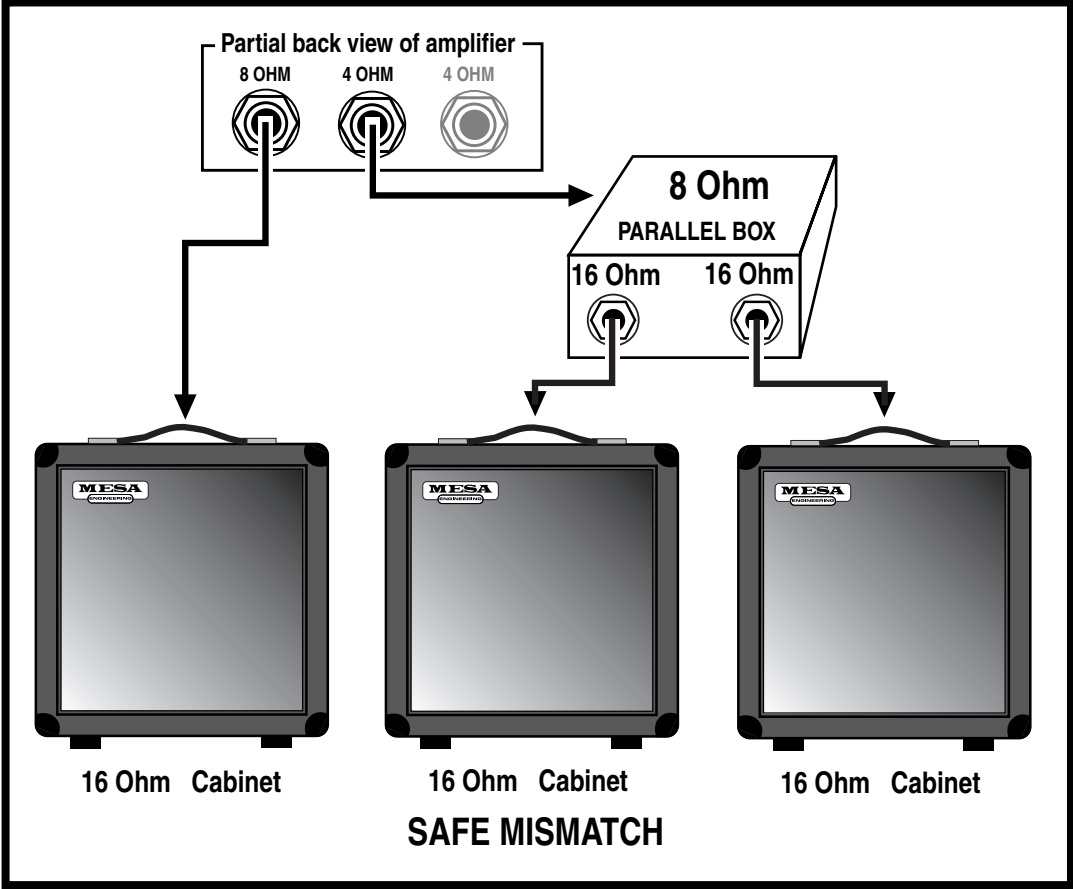

BEFORE CHANGING TUBES FLIP POWER & STANDBY SWITCH TO OFF

MARK FIVE: 25 HEAD TUBE REPLACEMENT

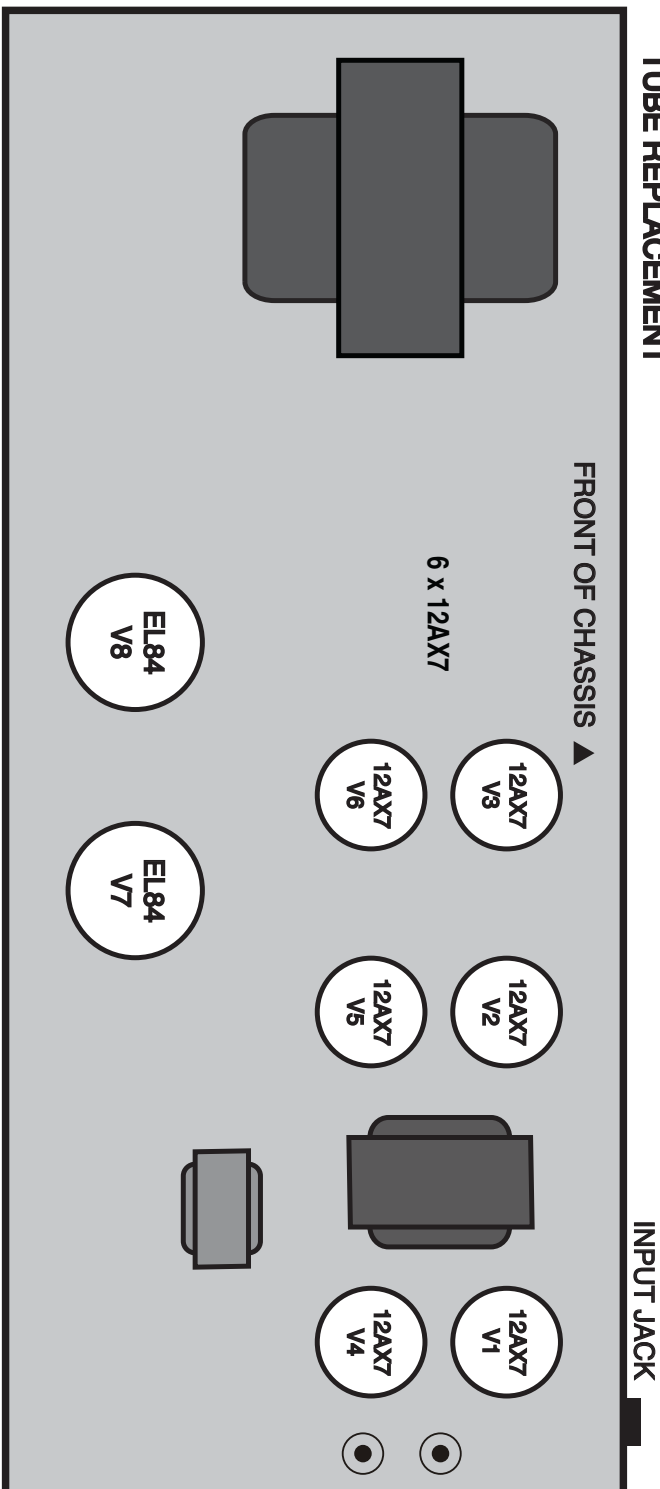

PREAMP TUBES

- V1A- Input Stage CH1 & CH2
- V1B- 2nd Gain Stage CH1 CLEAN & FAT
3rd Gain Stage CRUNCH
2nd Gain Stage CH2
- V2A- 2nd Gain Stage CH1 CRUNCH
- V2B- 4th Gain Stage CH2
- V3A- 3rd Gain Stage CH1 CLEAN & FAT
4th Gain Stage CRUNCH
- V3B- 4th Gain Stage CLEAN & FAT

- V4A- Reverb Return
- V4B- Reverb Send
- V5A- FX Loop Return
- V5B- 5th Gain Stage CH2
- V6A&B- Driver/Phase Inverter

POWER TUBES

- 25 Watts = V7, V8 Pentode
- 10 Watts = V7, V8 Triode

TO MAINTAIN WARRANTY, USE MESABOOGIE TUBES WHEN REPLACEMENT IS NECESSARY

FOR CUSTOMER SUPPORT, PLEASE CALL 707-778-6565 MONDAY-THURSDAY 9-5 PST, OR EMAIL US AT INFO@MESABOOGIE.COM

FRONT PANEL: MARK FIVE: 25

ALL FRONT PANEL KNOBS
PT# 408601

5x SLIDER KNOBS
pt# 408550

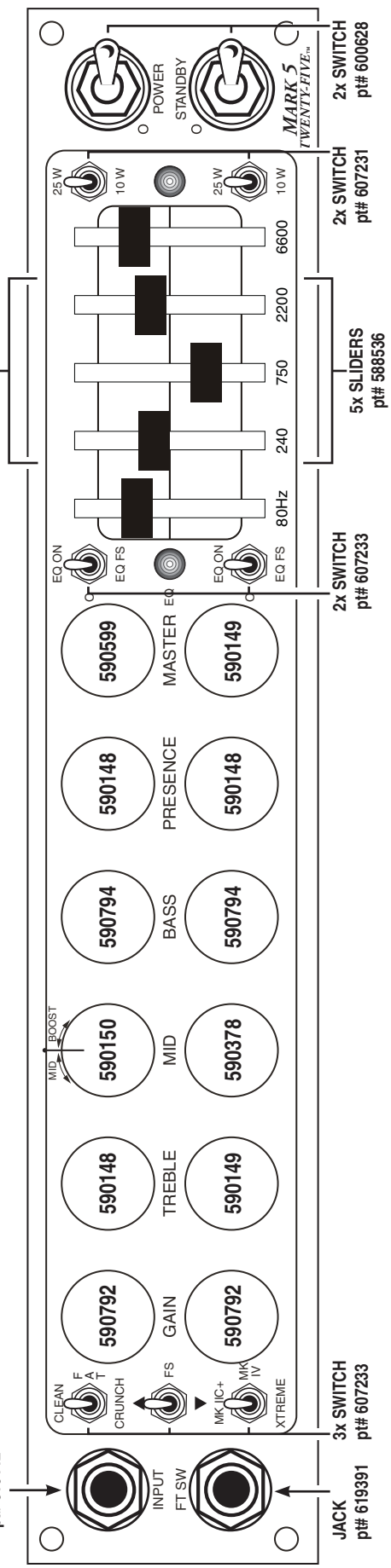

REAR PANEL: MARK FIVE: 25

2x KNOB
pt# 408601

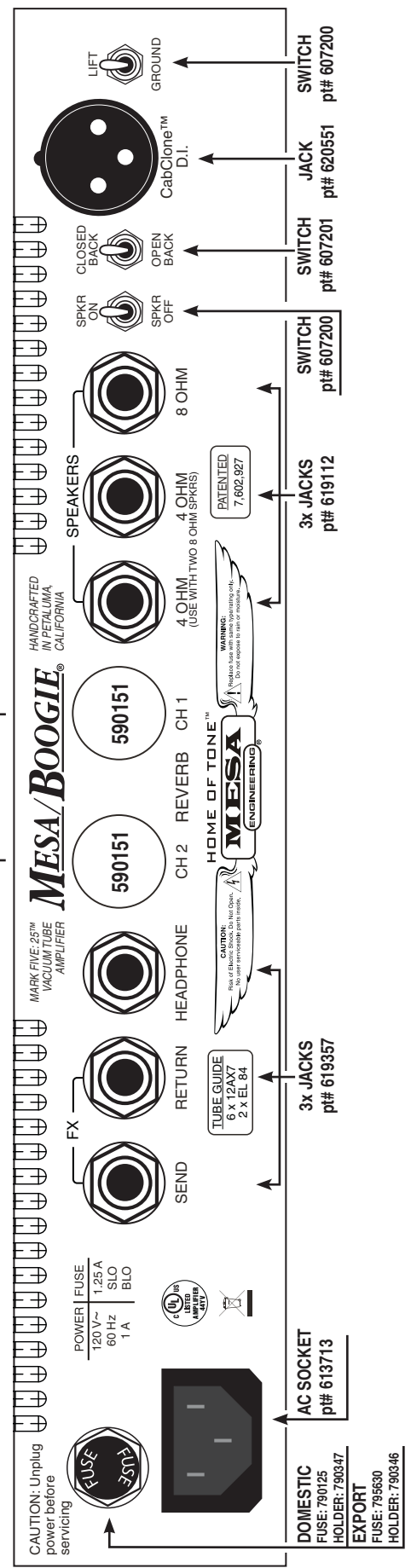

MESA/BOOGIE

The Spirit of Art in Technology

Thank you for trusting MESA/Boogie to be your amplifier company and we wish you many years of toneful enjoyment from this handbuilt all tube instrument.

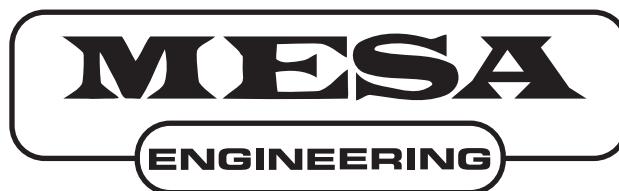

The Spirit of Art in Technology



(707) 778-6565 FAX NO. (707) 765-1503

1317 Ross Street Petaluma, CA 94954

USA