

NUX

TS/AC 4K

White-Box Amp Modeling algorithm

NME-5 **TRIDENT** Guitar Processor



©2022 Cherub Technology-All rights reserved. No part of this publication may be reproduced in any form without prior written permission of Cherub Technology.

Designed and manufactured by Cherub Technology Co.,Ltd

www.nuxefx.com Made in China



Copyright

Copyright 2022 Cherub Technology Co. All rights reserved. NUX and TRIDENT are trademarks of Cherub Technology Co. Other product names modeled in this product are trademarks of their respective companies that do not endorse and are not associated or affiliated with Cherub Technology Co.

Accuracy

Whilst every effort has been made to ensure the accuracy and content of this manual, Cherub Technology Co. makes no representations or warranties regarding the contents.

WARNING!-IMPORTANT SAFETY INSTRUCTIONS BEFORE CONNECTING, READ INSTRUCTIONS

WARNING: To reduce the risk of fire or electric shock, do not expose this appliance to rain or moisture.

CAUTION: To reduce the risk of fire or electric shock, do not remove screws. No user-serviceable parts inside. Refer servicing to qualified service personnel.

This device complies with part 15 of the FCC Rules. Operation is subject to the following two conditions: (1) this device may not cause harmful interference, and (2) this device must accept any interference received, including interference that may cause undesired operation. Any changes or modifications not expressly approved by the party responsible for compliance could void the user's authority to operate the equipment.

NOTE: This equipment has been tested and found to comply with the limits for a Class B digital device, pursuant to Part 15 of the FCC Rules. These limits are designed to provide reasonable protection against harmful interference in a residential installation. This equipment generates, uses and can radiate radio frequency energy and, if not installed and used in accordance with the instructions, may cause harmful interference to radio communications. However, there is no guarantee that interference will not occur in a particular installation.

If this equipment does cause harmful interference to radio or television reception, which can be determined by turning the equipment off and on, the user is encouraged to try to correct the interference by one or more of the following measures:

- Reorient or relocate the receiving antenna.
- Increase the separation between the equipment and receiver.
- Connect the equipment into an outlet on a circuit different from that to which the receiver is connected.
- Consult the dealer or an experienced radio/TV technician for help. The device has been evaluated to meet general RF exposure requirement. The device can be used in portable exposure condition without restriction.



The lightning symbol within a triangle means "electrical caution!" It indicates the presence of information about operating voltage and potential risks of electrical shock.



The exclamation point within a triangle means "caution!" Please read the information next to all caution signs.

1. Use only the supplied power supply or power cord. If you are not sure of the type of power available, consult your dealer or local power company.
2. Do not place near heat sources, such as radiators, heat registers, or appliances which produce heat.
3. Guard against objects or liquids entering the enclosure.
4. Do not attempt to service this product yourself, as opening or removing covers may expose you to dangerous voltage points or other risks. Refer all servicing to qualified service personnel.
5. Refer all servicing to qualified service personnel. Servicing is required when the apparatus has been damaged in any way, such as when the power supply cord or plug is damaged, liquid has been spilled or objects have fallen into the apparatus, the apparatus has been exposed to rain or moisture, does not operate normally or has been dropped.
6. The power supply cord should be unplugged when the unit is to be unused for long periods of time.
7. Protect the power cord from being walked on or pinched particularly at plugs, convenience receptacles and at the point where they exit from the apparatus.
8. Prolonged listening at high volume levels may cause irreparable hearing loss and/or damage. Always be sure to practice "safe listening".

Follow all instructions and heed all warnings
KEEP THESE INSTRUCTIONS!

Introduction

Thank you for your purchase of the TRIDENT integrated effect pedalboard. Since the release of the Cerberus integrated effect a few years ago, we set out to develop a new pedalboard. It needed to share elements of the original Cerberus design along with uncompromising tone, simple operation, and intuitive tweaking response. And it needed to have a powerful software based editor for the best overall experience. We believe the TRIDENT will offer you that great experience.

*This is a quick start manual to get you up and running quickly with the TRIDENT. If you are looking for in-depth information, please visit the product page and Facebook discussion group.

The TRIDENT is the first one integrated effect which uses our iconic TSAC-4K Amp Modeling (White-box Physical Modeling algorithm). The TSAC-4K Amp Modeling algorithm is twice as complex than previous versions. This led us to design a new hardware platform with 2 DSPs, one to handle all the effects, and the other one to handle the amp modeling algorithm. Additionally, the TRIDENT uses premium A/D & D/A converters and analog circuits to achieve a clear sound with low noise levels.

This world-class amp modeling algorithm comes fully loaded with features and functionality. Just like their real counterparts, the amps have HIGH / LOW inputs, 4 inputs for patch cable jumping, toggle switch for voicing, for max tweaking. The knob layout, toggle switches, and foot switches of the TRIDENT are intuitive like stomp boxes, you can engage/disengage the effects freely. The SELECT & PARAM encoders with LCD display deliver more parameter details, block order / status.

Perfect for live applications, the TRIDENT offers plenty of I/O options. The SEND / RETURN effect loop for external effects, 2 balanced XLR outputs to the PA system, PHONES output for monitoring, EXP. PEDAL for expression pedal, MASTER VOL pot for overall volume, and MIDI IN / OUT.

Build like a tank. The TRIDENT uses one-piece die-cast aluminum chase, it's solid, strong, build for live performance.

The TRIDENT is also a powerful studio device. You can download Trident Editor™ from the product page to edit patches, and setup the USB routing. The TRIDENT can do USB dry-out and reamp, so it's useful to create guitar tracks with mixing.

Warning!! In order to offer you the best dynamic range of USB Streaming, the TRIDENT doesn't attenuate the PC's system playback volume. When using the TRIDENT as a USB audio interface, remember to adjust your PC's playback volume from the "minimum" to the desired volume. Take care of your ears.

Thank you for choosing the TRIDENT. Please remember to visit the product page often or Facebook discussion group to get the newest information, firmware, editor version.

Overview

Front Panel

LEVEL Knob[®]
 TIME Knob
 REPEAT Knob
 DLY types 3-way Toggle Switch[®]

LEVEL Knob[®]
 DECAY Knob
 RVB 3-way Toggle Switch[®]

DLY&RVB Routing 3-way Toggle Switch[®]

RATE Knob
 LEVEL Knob^①
 MOD 3-way Toggle Switch[®]

SENSE Knob
 LEVEL Knob^②
 FX 3-way Toggle Switch[®]

DEPTH Knob



Overview



SELECT Knob(Encoder)
 PARAM Knob(Encoder)
 DISPLAY

GAIN Knob
 LEVEL Knob
 BASS Knob
 MIDDLE Knob
 TREBLE Knob
 PRESENCE Knob

NR Button
 AMP Button
 CAB Button
 EQ Button

UP Foot Switch
 REVERB Foot Switch
 DELAY Foot Switch
 MOD Foot Switch
 FX Foot Switch

DOWN Foot Switch
 A Foot Switch
 B Foot Switch
 C Foot Switch
 BOOST Foot Switch

Rear Panel

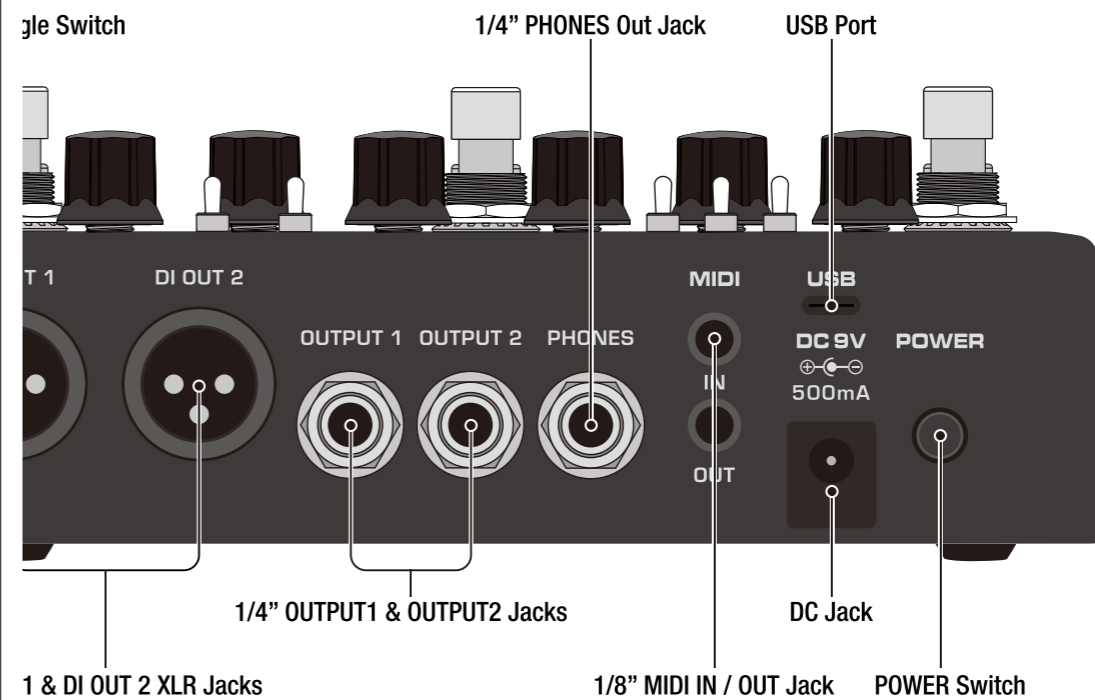
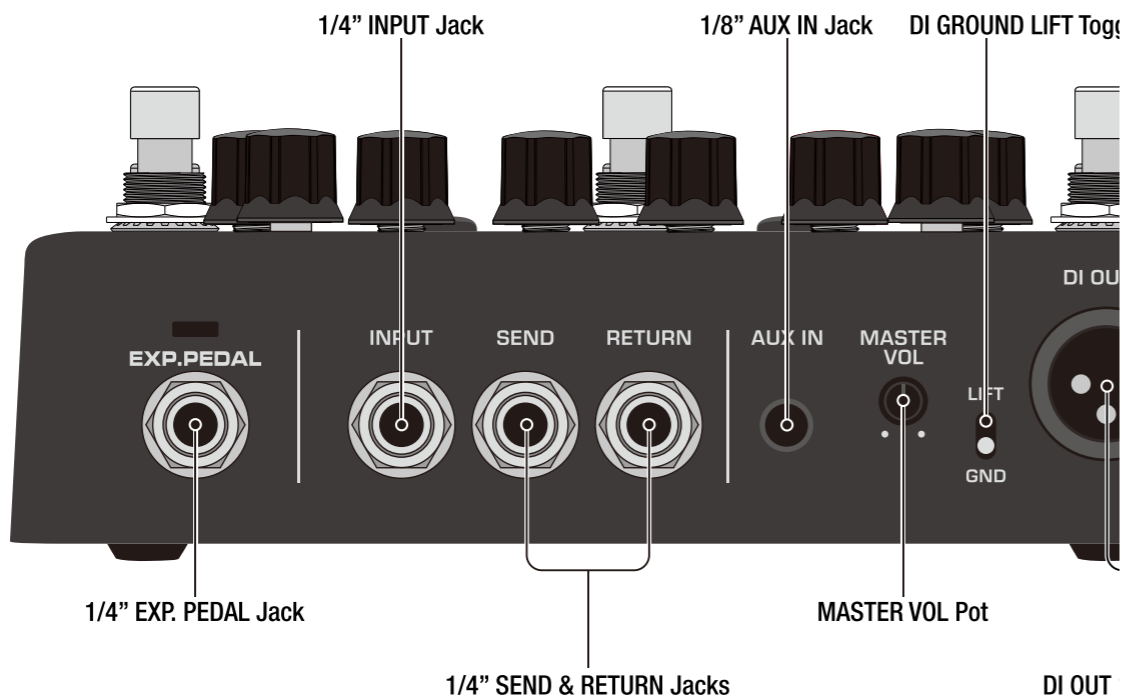

Overview

- One-piece die-cast aluminum chassis.
- World-class amp modeling algorithm with full functions. (Like 4 inputs for patch cable jumping.)
*Currently 27 AMP models.
- White-box Amp Modeling & Pre-efx algorithm offers realistic playability and analog-chaos response. *Currently 7 BOOSTS, 7 FXs.
- Modulation, Delay, Reverb. *Currently 11 Modulations, 3 Delays, 4 Reverbs.
- NR, BST, EFX, AMP, CAB, EQ, S/R, MOD, DLY, RVB | 10 independent moveable signal blocks.
- 1024 samples IR resolution and USER slot with each patch. (additional 32 custom IR slots)
- Real knob adjusting for FX, MOD, REVERB, DELAY.
- Real knob adjusting for Amp models.
- 96 preset slots. (32 A / B / C)
- 60 seconds phrase looper, PRE / POST position available.
- PARA. FOLLOW function can track your effect tweaking habits.
- USB audio interface, firmware update, Trident Editor™ edit software.
- MIDI IN/OUT, EXP. PEDAL jack, SEND / RETURN effect loop, stereo balanced DI outs, MASTER VOL pot.

Quick Operation

Preparing

1. Firstly, make sure the TRIDENT and the connected amplifier (monitors or FRFR speakers) are turned off. Set the MASTER VOL to minimum value. Connect your guitar to INPUT, and connect the related amplifiers (or monitors, FRFR speakers) to OUTPUT1 & OUTPUT2 or DI OUT1 & DI OUT2.
2. Connect the including adaptor ACD-006A to DC 9V jack, press the POWER button. And turn on the related amplifiers.
3. Adjust the MASTER VOL pot to desired position. (maybe less than the 50%)

Warning!! In order to offer you the best dynamic range of USB Streaming, the TRIDENT doesn't attenuate the PC's system playback volume. When using the TRIDENT as a USB audio interface, remember to adjust your PC's playback volume from the "minimum" to the desired volume. Take care of your ears.

4. Set OUTPUT MODE: Press the SELECT & PARAM encoders to enter to GLOBAL SETTING, then short press the SELECT encoder to access OUTPUT MODE. Now, rotate the SELECT encoder to choose your desired output mode, then press SELECT encoder to save the output mode.

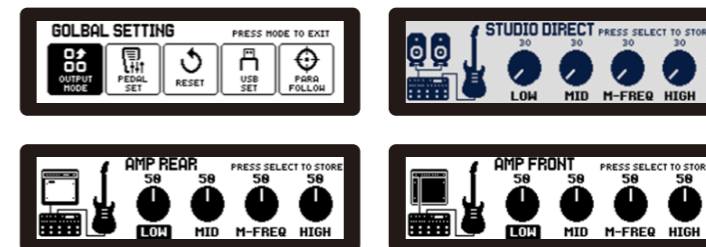

*CAB block will be engaged under STUDIO DIRECT mode, others will disengage CAB block.

*STUDIO DIRECT offers line signal with CAB(IR). AMP FRONT offers instrument signal without CAB(IR). AMP REAR offers line signal without CAB(IR).

Quick Operation

Start tweaking & playing

Once you boot-up the TRIDENT, it will be in PRESET MODE.



1. Press the UP / DOWN foot switch to choose the target preset group, in the meantime, the group digit (01~32) will flash. Then press either the A or B or C foot switches to choose the desired patch. (For example, 01-A)
2. Under PRESET MODE, you can also adjust the SELECT knob to select a patch.
3. The TRIDENT includes 96 factory presets, and 96 user slots. Under PRESET MODE, short press SELECT knob can call FACTORY preset, and press SELECT knob again to go back to the user slot. All the FACTORY presets were made by professional musicians and session players, it's a good reference for the tone tweaking.
4. FX, BOOST, MOD, DELAY, and REVERB blocks can be engaged / disengaged by the related foot switches.
5. Under PRESET MODE, the DELAY block has "Smart Tap Tempo" function. You can setup desired sub-division in DLY editing.
*Smart Tap Tempo is patent pending. Press once to engage / disengage the effect, press more than twice, it will become TAP TEMPO immediately.
6. Under PRESET MODE, press NR, AMP, CAB, and EQ buttons to engage / disengage the related blocks.

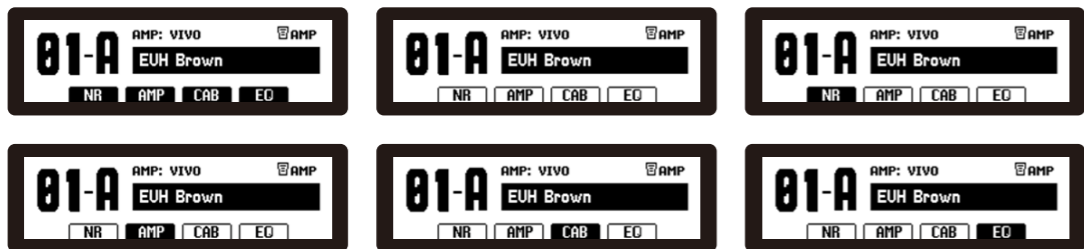

7. Adjust the related knobs for the target effect block, engage / disengage the blocks for your own preset.

For deeper tone adjustments, you can press PARAM encoder to enter to EDIT MODE, in the meantime you can rotate the PARAM knob to choose a target block (which will be upper), then press the PARAM knob to enter the block. Under the related block, each page has 4 parameters, you can move to the target parameter by pressing NR / AMP / CAB / EQ buttons.

Quick Operation

Deeper adjustments in EDIT MODE

1. Press the PARAM encoder to enter to EDIT MODE. You can see the engagement status, and routing order of all the blocks for the current preset.

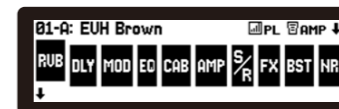

2. Under EDIT MODE, before entering to specific block editing, you can rotate SELECT knob or press UP / DOWN and A / B / C foot switch to choose the target preset for deeper adjustments.
3. Short press related block foot switches (BOOST / FX / MOD / DELAY / REVERB) or buttons (NR / AMP / CAB / EQ) can engage / disengage the related blocks. Quickly press the target foot switch or button can enter to the target block editing.
4. Under EDIT MODE, rotate the PARAM knob to choose the target block (which will be upper). In the meantime, you can press the PARAM knob and hold it for 2 seconds, then the block will flash. Now you can rotate the PARAM knob to adjust the block's order. Press the PARAM knob again to confirm the current order.
5. DLY and RVB blocks' order and routing are controlled by the " // -> <- " toggle switch, and the order is also mutual adjusted by rotating the PARAM knob.
6. While you choose the target block, press the PARAM knob or click the related foot switch / button twice to enter the target block editing.
7. Under target block editing, there are mostly 4 parameters in each page. Rotate the PARAM knob to adjust the related parameter. (Press the NR / AMP / CAB / EQ button to choose the target parameter. You can see the parameter which is demarcated.) Press the PARAM knob again to quit to EDIT MODE. You can choose another block for adjusting.
And yes, the related effects' physical knobs can adjust the tone directly.
8. Even under target block tweaking, short press the related block foot switch (BOOST / FX / MOD / DELAY / REVERB) or button (NR / AMP / CAB / EQ) twice can enter to the different target block tweaking.

Phrase Looper

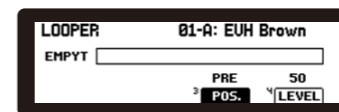

Quick Operation

Start tweaking & playing

1. Press and hold the FX foot switch for 2 seconds to access the LOOPER. Under LOOPER MODE, FX foot switch becomes REC/DUB, MOD foot switch becomes PLAY/STOP, DELAY foot switch becomes UNDO/REDO, REVERB foot switch becomes CLEAR.
2. Press the CAB button to choose the LOOPER position (POS.), in the meantime you can rotate the PARAM knob to adjust PRE or POST. PRE means the phrase looper is in the beginning of signal chain, what you record is the dry signal, while you play the phrase looper, you can tweak the effects' parameters to change the sound for tone tweaking. POST means the phrase loop is in the end of signal chain, what you record is the processed signal, while you play the phrase looper, you cannot change the sound of the recorded loop.
3. Press the EQ button to choose the LOOPER level (LEVEL). Rotate the PARAM knob to adjust the phrase loop playing volume.
4. While there is phrase loop, the display will show EMPTY on the left side. In the meantime, press REC/DUB foot switch to record. The indicator bar will show the left recording time.

REC/DUB foot switch

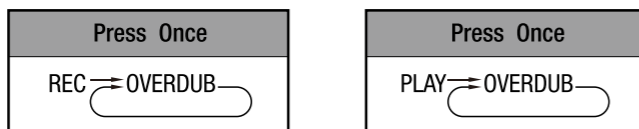

5. Press the PLAY/STOP foot switch to stop recording and play the phrase looper immediately. Once you press the PLAY/STOP foot switch again, the phrase looper will stop.

PLAY/STOP foot switch



6. Since it has phrase loop, press the REC/DUB foot switch to overdub the phrase looper. The overdub will keep going until you press the PLAY/STOP foot switch, then it will play the phrase looper including what you overdub for the newest layer. You can press UNDO/REDO foot switch to undo the newest layer, and redo if you want to recall the newest layer.

Quick Operation

UNDO/REDO foot switch

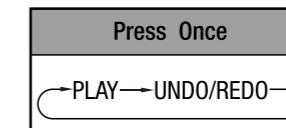

7. Short press CLEAR foot switch to delete the current phrase loop.
8. Hold CLEAR foot switch for 2 seconds to quit LOOPER MODE. You can quit LOOPER MODE even the phrase loop is playing, and enter LOOP MODE again by holding the REC/DUB foot switch for 2 seconds. While you turn off TRIDENT, it will delete the phrase loop.

CLEAR foot switch

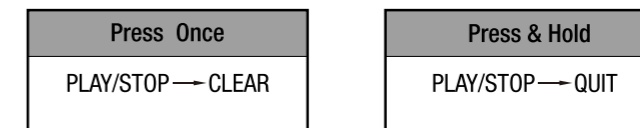

9. The maximum loop length is 60 seconds.

LOOPER MODE foot switch operation logic

REC/DUB foot switch

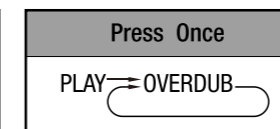
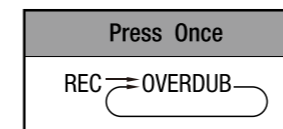

PLAY/STOP foot switch

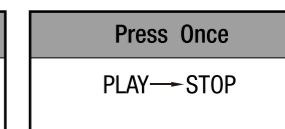
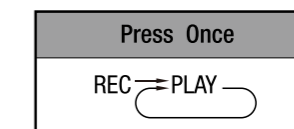

UNDO/REDO foot switch

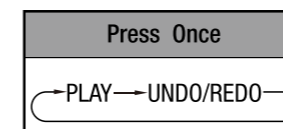

CLEAR foot switch

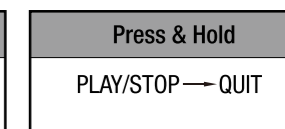
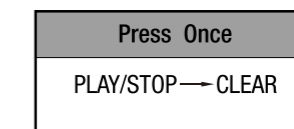

Quick Operation

Tuner Mode



1. Hold the BOOST foot switch for 2 seconds to enter to TUNER MODE.
2. Under TUNER MODE, rotate the PARAM knob to adjust A4 frequency. (430~450 Hz)
3. Press EQ to engage / disengage monitoring.
4. Press any foot switch to quit TUNER MODE.

Control Panel

SELECT Knob(Encoder) & PARAM Knob(Encoder) , DISPLAY



Under PRESET MODE, press the PARAM & SELECT knobs simultaneously to enter to GLOBAL SETTING.



Once in GLOBAL SETTING, you can press PARAM knob to. Or rotate the SELECT knob to choose target function. Press the SELECT knob once to enter the target function, press the PARAM knob to quit to upper layer.

1. OUPUT MODE:

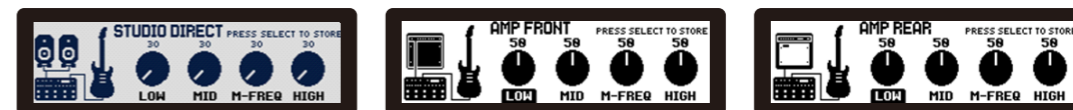

Once in OUTPUT MODE, you can rotate the SELECT knob to choose the output mode. As you can see the display has 4 parameters: LOW, MID, M-FREQ, HIGH. These are global EQ in the end of signal chain. Use the NR/AMP/CAB/EQ buttons to highlight the LOW/MID/M-FREQ/HIGH paraments for editing. Then rotate the PARAM knob to adjust the related parameters. Press the SELECT knob to save, or press the PARAM knob to quit.

2. PEDAL CALIBRATION:



Follow the display guide, it's intuitive to operate.

Control Panel

3. RESET:

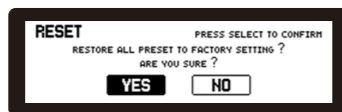

4. USB SET:

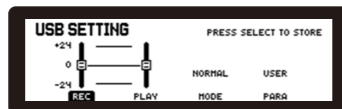

Use the NR/AMP/CAB/EQ buttons to highlight the REC/PLAY/MODE/PARA parameters for editing. Then rotate PARAM knob to adjust the related parameters. Press the SELECT knob to save, or press the PARAM knob to quit.

5. PARA FOLLOW:

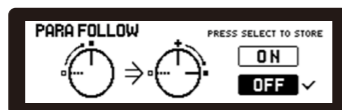

Engaging the PARA FOLLOW function to remember your parameter tweaking habits.

6. MIDI:

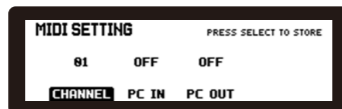

EDIT MODE

Under PRESET MODE, press the PARAM knob to enter to EDIT MODE.

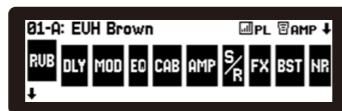

Under EDIT MODE, you can see the blocks' engagement status. Rotate the PARAM knob to choose target tweaking block. (Which will become upper, for example as you can see RVB block is upper.) Then press PARAM to enter the target block.

Control Panel

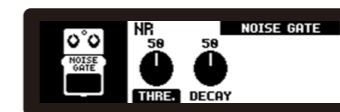

For example, now you are in NR block, then you can press the NR button to highlight THRE., and press AMP button to highlight DECAY. Then rotate PARAM knob to tweak the related parameters. If you want to save the parameters, press & hold SELECT knob to save the patch.

If you want to change the block order, rotate PARAM knob to highlight the target block, press and hold PARAM knob, then the current block will flash. In the meantime, you can rotate PARAM knob to move the block order. Press PARAM knob again to confirm the current position. After the tweaking, press & hold SELECT knob to save the patch.

Under EDIT MODE, press SELECT as home button to go back to PRESET MODE immediately.

The GAIN, LEVEL, BASS, MIDDLE, TREBLE, PRESENCE Knobs (related to AMP block) and NR, AMP, CAB, EQ Buttons



Under PRESET MODE, you can press the NR, AMP, CAB, EQ buttons to engage/disengage the related blocks.



Either under PRESET MODE or EDIT MODE, you can tweak the GAIN, LEVEL, BASS, MIDDLE, TREBLE, PRESENCE knobs to adjust the parameters of AMP block.

Control Panel

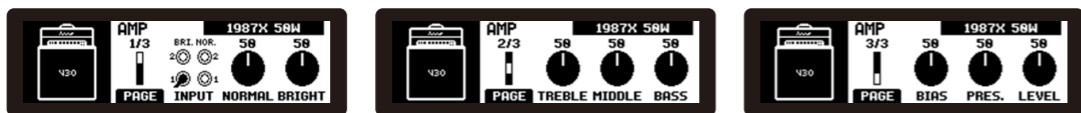

RATE, LEVEL Knobs^①, MOD 3-way Toggle Switch^③
SENSE, LEVEL Knobs^②, FX 3-way Toggle Switch^④
DEPTH Knobs



Either under PRESET MODE or EDIT MODE, you can tweak RATE, EDPTH, LEVEL knobs^① to adjust the parameters of MOD block; you can tweak SENSE, LEVEL knobs^② to adjust the parameters of FX block.

FX block: Use the FX 3-way toggle switch^④ to choose the category.

COMP

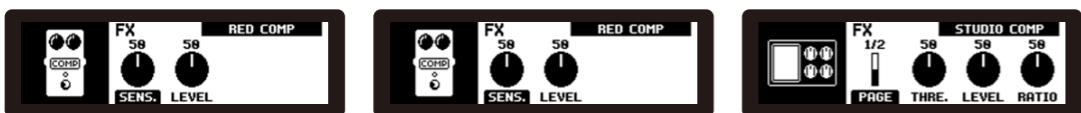

FILTER



Control Panel

PITCH



MOD block

Use the MOD 3-way toggle switch^③ to choose the category.

CHOR

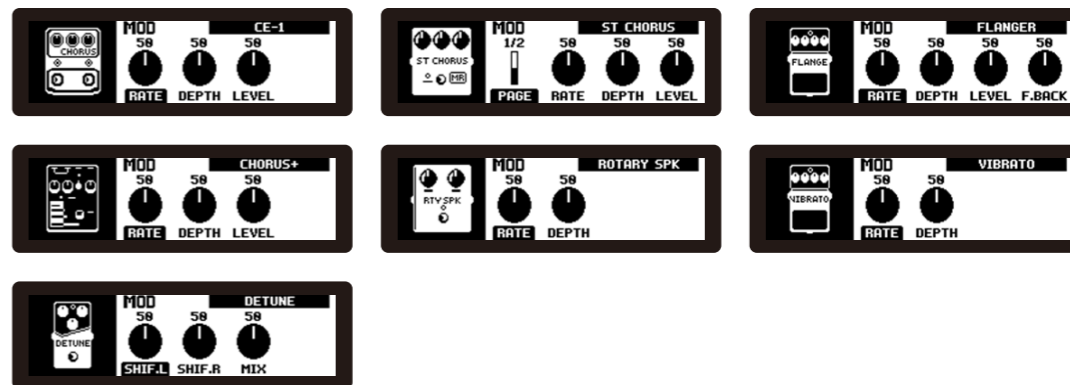

TREM

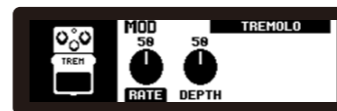

PHAS

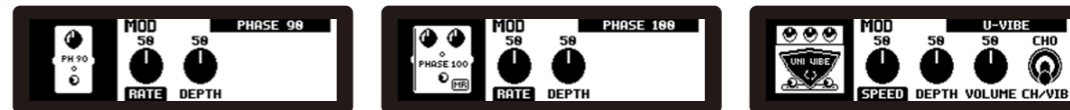

(These models are based on Firmware V1)

Control Panel

LEVEL[®], TIME, REPEAT Knobs, DLY types 3-way Toggle Switch[®]
 LEVEL[®], DECAY Knobs, RVB 3-way Toggle Switch[®]
 DLY&RVB Routing 3-way Toggle Switch[®]



Either under PRESET MODE or EDIT MODE, you can tweak LEVEL[®], TIME, REPEAT knobs to adjust the parameters of DLY block; you can tweak LEVEL[®], DECAY knobs to adjust the parameters of RVB block.

DLY block

Use DLY 3-way toggle switch[®] to choose the category.

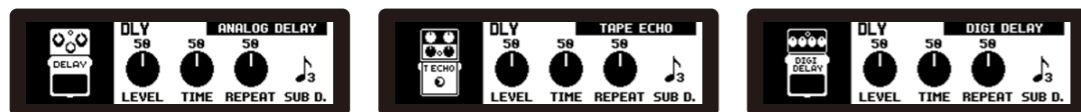

DELAY Block & REVERB Block Routing Toggle Switch[®]

Use this toggle switch to set the signal routing of DELAY Block & REVERB Block.

RVB block

Use RVB 3-way toggle switch[®] to choose the category.



***Note:** In the HAL slot, you have ROOM and HALL reverb models. (Firmware V1)

Control Panel

UP, REVERB, DELAY, MOD, FX, DOWN, A, B, C, BOOST Foot Switches



Under PRESET MODE, you can press UP / DOWN to change the bank group digit (01~32), then press A / B / C to the target patch location.

Under PRESET MODE, you can press the BOOST / FX / MOD / DELAY / REVERB foot switches to engage / disengage the related blocks. Press the DELAY foot switch two or more times to access the SMART TAP function.

Under EDIT MODE, you can press the BOOST / FX / MOD / DELAY / REVERB foot switch to enter the related block.

Under PRESET MODE, press & hold BOOST for 2 seconds to enter to TUNER MODE. Press any foot switch to quit TUNER MODE.



Under PRESET MODE, press & hold FX foot switch to enter to LOOPER MODE. In the meantime, FX foot switch becomes REC/DUB, MOD foot switch becomes PLAY/STOP, DELAY foot switch becomes UNDO/REDO, REVERB foot switch becomes CLEAR.

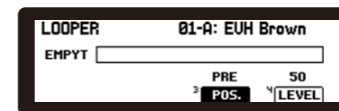

Control Panel

LOOPER MODE foot switch operation logic

REC/DUB foot switch

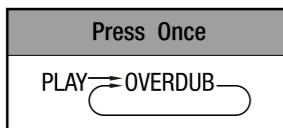
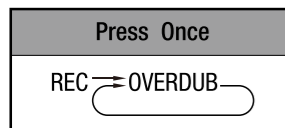

PLAY/STOP foot switch

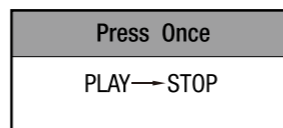
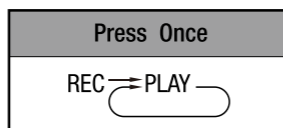

UNDO/REDO foot switch

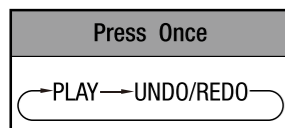

CLEAR foot switch

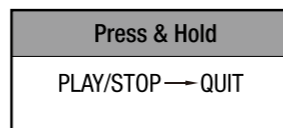
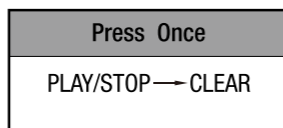

Rear Panel

POWER Switch

POWER



Connect the included power adaptor ACD-006, then press the POWER switch to turn on the device.

DC Jack

DC 9V
500mA



Connect the included adaptor (ACD-006A) to the jack.

USB Port

USB



Connect the USB cable to your computer for firmware updates, USB audio recording, or Trident™ edit software editing.

***Note:** Connect USB cable to computer, and hold UP & REVERB foot switches to turn on TRIDENT, then you can enter to DFU (Device Firmware Update) mode to do firmware update. For more details, please visit product page to check the firmware update guide and download the newest firmware & Trident™ edit software.

*For WIN, you must download and install the related ASIO driver from the product page. To avoid Trident™ editor and USB audio stream connection issues, please unplug any other unnecessary USB MIDI devices or HUBs, and connect TRIDENT directly to a USB port. If your laptop experiences connection issues, please try to update and reinstall the laptop's USB port driver or Windows Service Pack. TRIDENT uses standard USB communication, there may be some interferences related to USB hardware and/ or HUBs, especially USB MIDI devices.

*For issue replies and questions, please offer this information, it will be helpful for us to figure out.

1. Firmware version before Firmware Update.
2. DFU Updater version

Rear Panel

3. PC OS version (for example, MAC Big Sur 11.0.1)
4. Current Firmware Version which has issues
5. Issue description
6. Screenshot of Trident™ editor connection or issue video

1/8" MIDI IN / OUT Jack

MIDI
IN
OUT



Connect an external MIDI device here. You can find the included 1/8" to 5 pin MIDI adaptors in the giftbox.

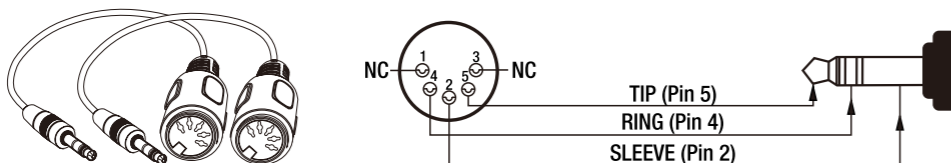

Note: Do not connect an audio device here. Doing so will cause malfunctions.

1/4" PHONES Out Jack



Connect your headphone to this output jack. The impedance is 47Ω.

Rear Panel

1/4" OUTPUT1 & OUTPUT2 Jacks

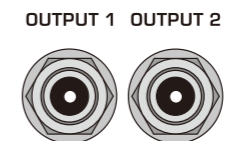

OUTPUT 1 is unbalanced for mono, OUTPUT 2 is unbalanced for right side while stereo application. The impedance is 1kΩ.

DI OUT 1 & DI OUT 2 XLR Jacks DI GROUND LIFT Toggle Switch

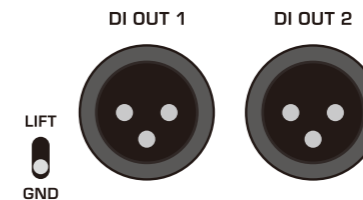

The DI OUT 1 is balanced mono out, the DI OUT 2 is balanced right side while stereo application. The DI GROUND LIFT toggle switch can solve common ground issue in case.

MASTER VOL Pot



The MASTER VOL potentiometer can adjust overall output level.

Tips: Please adjust the pot from minimum setting to the target volume you feel comfortable with. It's usually loud enough when set at 12 o'clock. Protect your hearing!

Rear Panel

1/8" AUX IN Jack

AUX IN



Connect your MP3 player to the 1/8" AUX IN jack for playback.

1/4" SEND & RETURN Jacks



Connect external pedals with the SEND/RETURN jacks. The SEND impedance: 1K Ω . The RETURN impedance: 100k Ω .

Mode: Serial, Parallel, Branch.

*Branch mode only SENDs the signal out.

1/4" INPUT Jack

INPUT



Connect your guitar to INPUT jack. The INPUT impedance: 1M Ω .

1/4" EXP. PEDAL Jack

EXP. PEDAL



Connect the external Expression pedal to control the related parameters like VOLUME (LEVEL), BOOST (GAIN / LEVEL), FX (SENS.), AMP (GAIN / LEVEL), MOD (RATE / DEPTH / LEVEL), DLY (LEVEL / TIME / REPEAT), RVB (LEVEL / DECAY).

Common Connections

STUDIO DIRECT

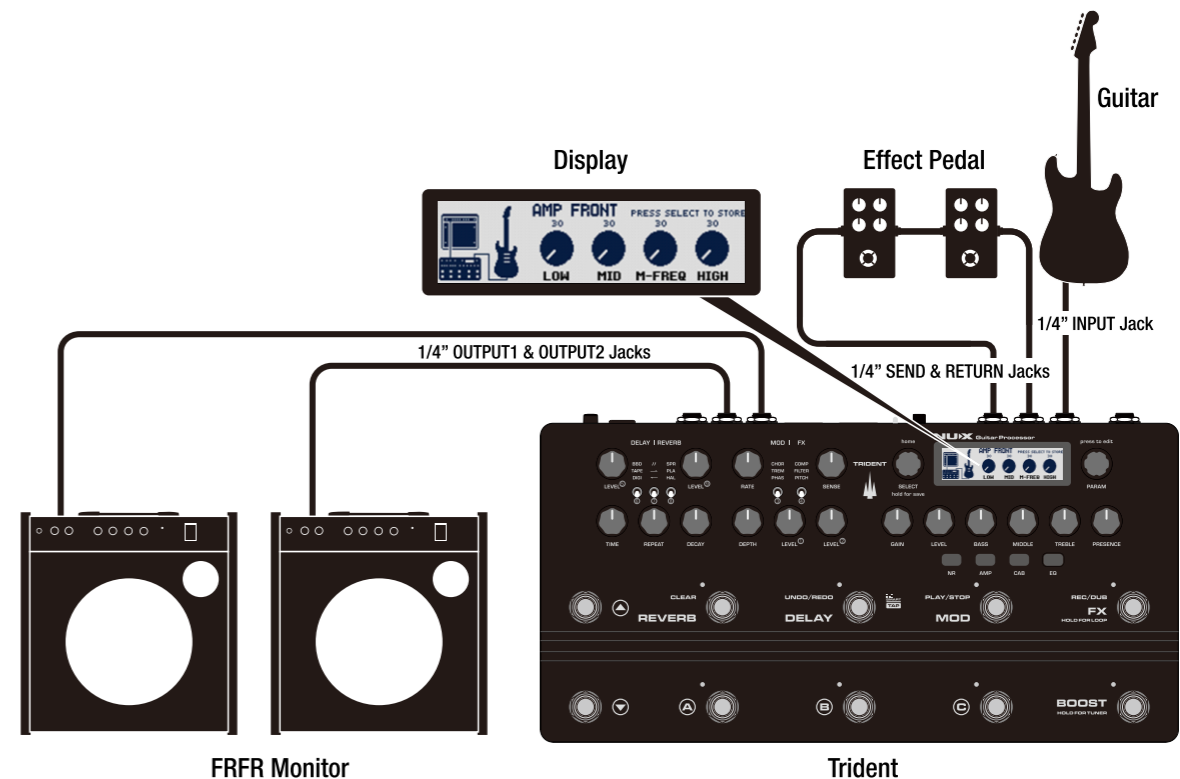

This is the recommended setup for best results when using the TRIDENT. It's also suitable for PHONES application.

You can connect the FRFR amplifiers or monitors with the 1/4" OUTPUT 1 & OUTPUT 2 or DI OUT 1 & DI OUT 2.

Common Connections

AMP'S POWER AMP IN or RETURN

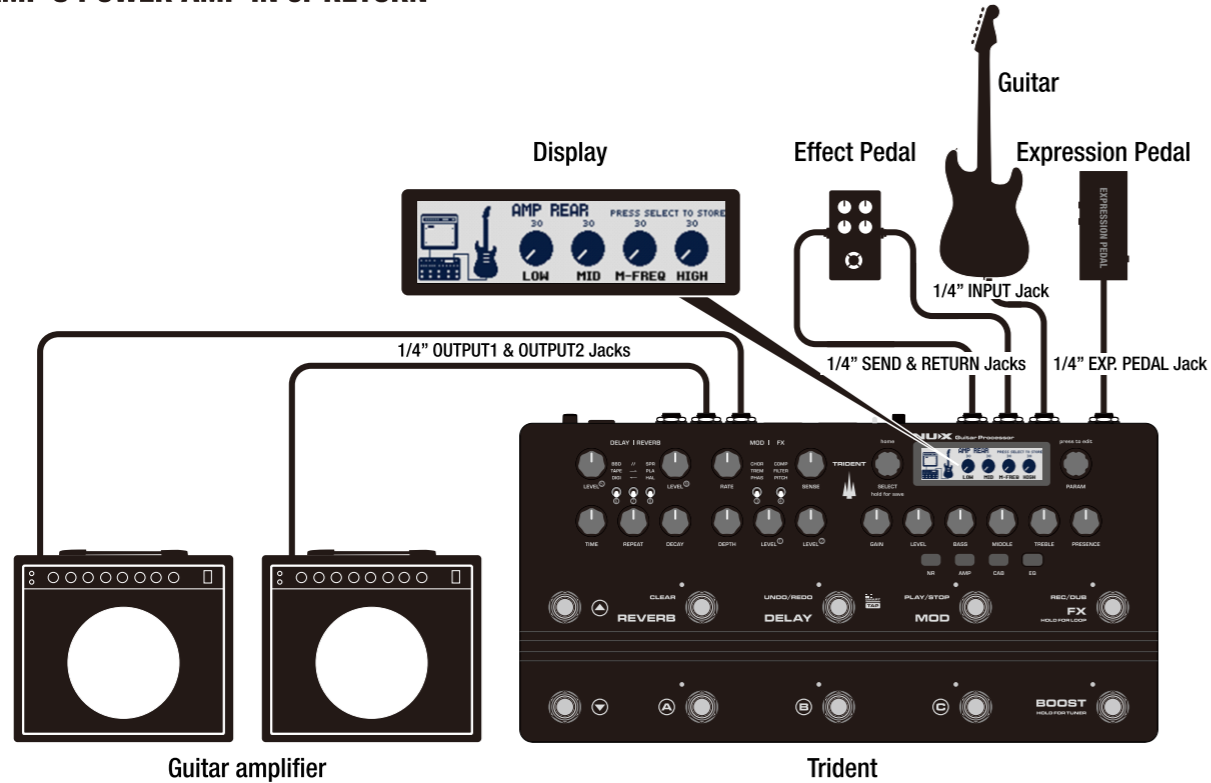

While you play on the stage with a guitar amplifier, you can connect TRIDENT's 1/4" OUTPUT 1 to the amplifier's power amp in / return. Under AMP REAR, the CAB (Impulse Response) block will be disengaged.

Common Connections

CABLE METHOD (4CM)

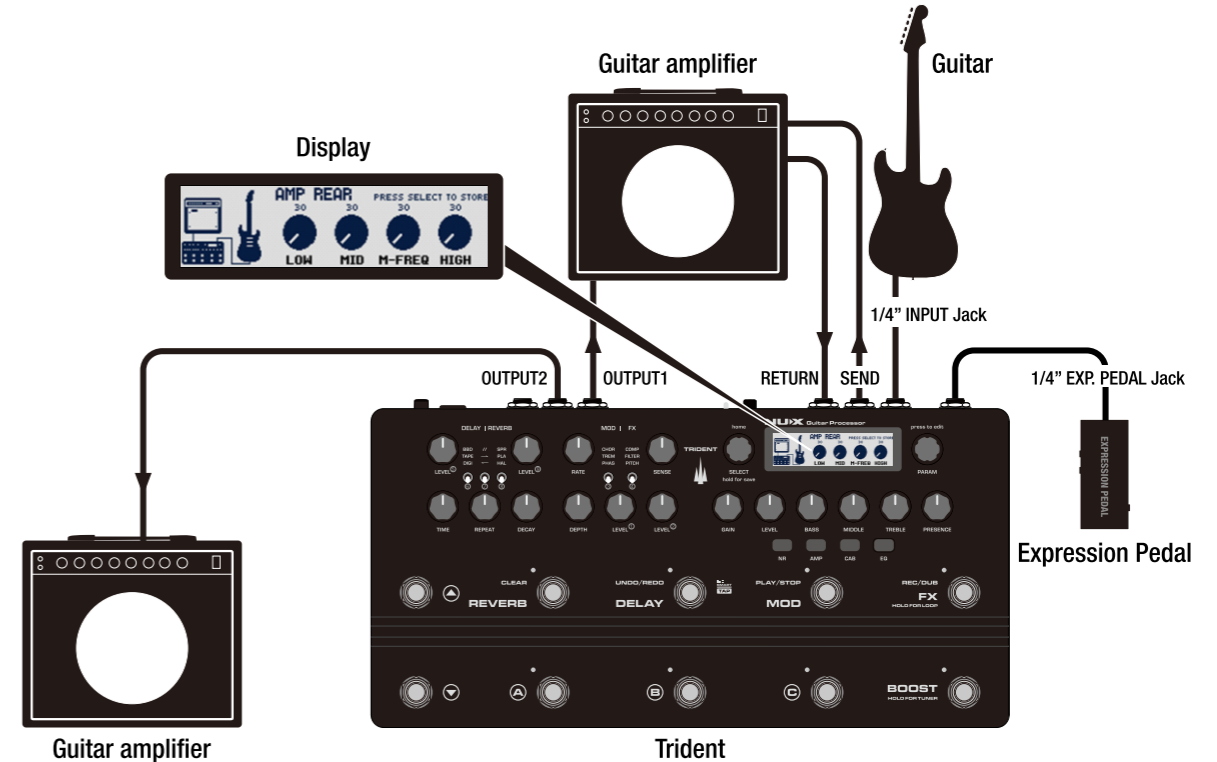

If you choose 4CM, it means you use the amplifier's preamp, TRIDENT's effects, amplifier's power amp with speakers. So, remember to setup the patches without AMP & CAB blocks, in the meantime, S/R block means the amplifier's preamp and you can adjust the S/R block order in the signal chain.

4 cables: (1) Guitar to TRIDENT's 1/4" INPUT jack. (2) TRIDENT's 1/4" SEND jack to the amp's INPUT jack. (3) The amp's SEND / PREAMP OUT jack to TRIDENT's 1/4" RETURN jack. (4) TRIDENT's 1/4" OUTPUT 1 jack to the amp's RETURN / POWER AMP IN jack.

Common Connections

POST EFFECTS

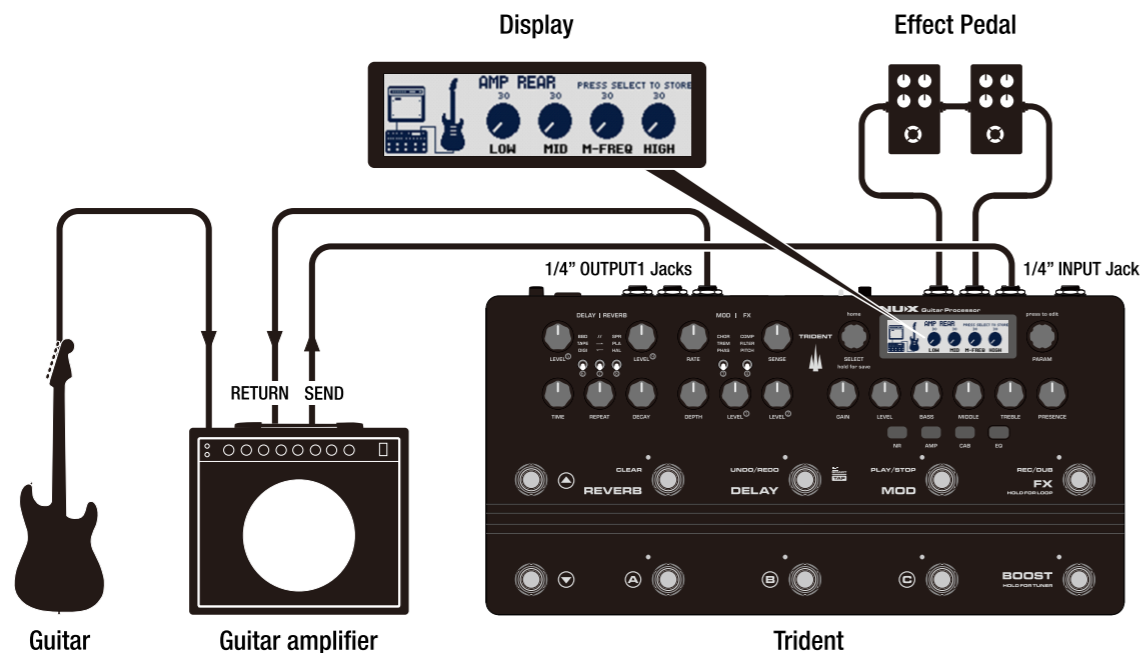

You can use the amp's preamp with TRIDENT's effects as post effects.

Connect the amp's SEND to TRIDENT's 1/4" INPUT jack, and TRIDENT's 1/4" OUTPUT 1 to the amp's RETURN. Plug your guitar into the amp's INPUT.

Remember to disengage the AMP & CAB(IR) blocks for the patches in this application. Then you can use all the post effects like EQ, MOD, DLY, RVB.

Common Connections

PRE-EFFECTS

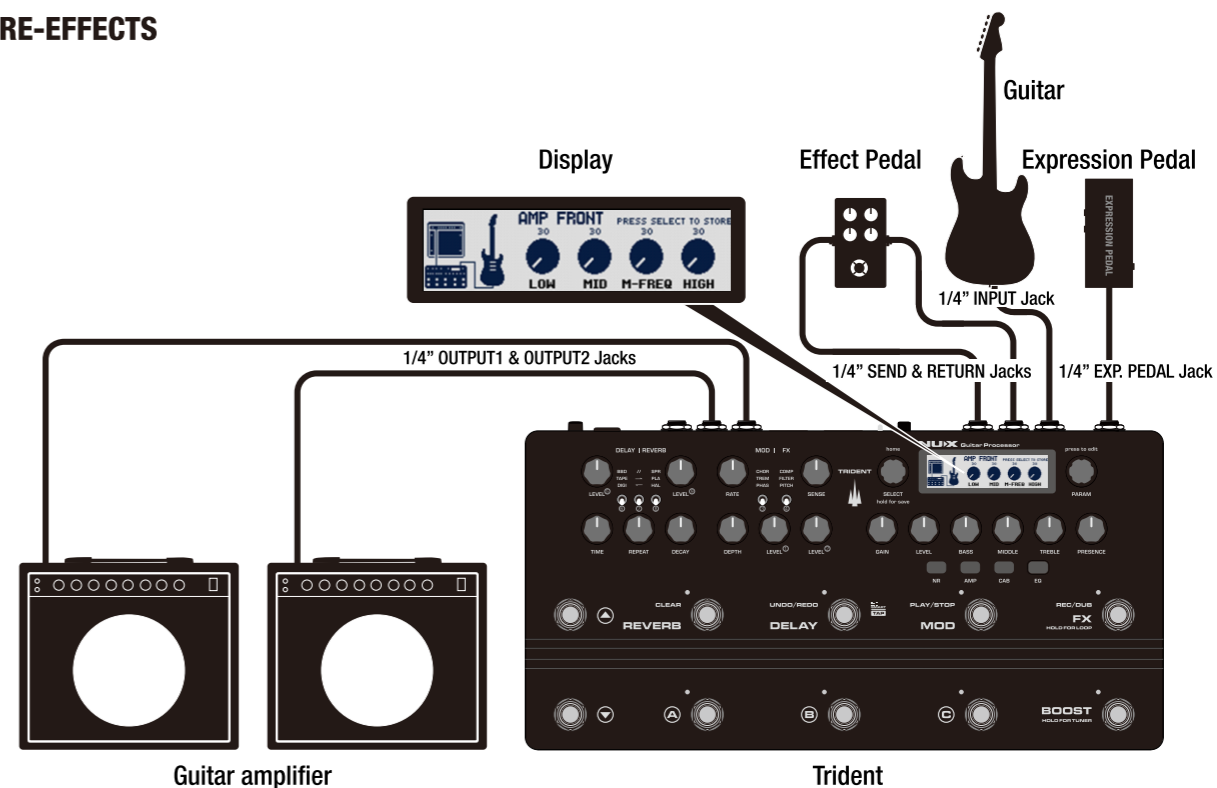

This is the simplest connection between the TRIDENT and your amplifier.

We won't recommend this connection, if there is no other choice, and this is the only way, please be careful for the tone tweaking.

In this application, try to bypass all the TRIDENT'S blocks in the beginning, and tweak the amp's EQ sounds as flat as possible. Then start to use TRIDENT's patches to play.

Global Setting

Under PRESET MODE, press the PARAM & SELECT knobs simultaneously to enter to GLOBAL SETTING.

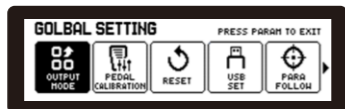

In the meantime, you can press PARAM to quit GLOBAL SETTING. Or rotate the SELECT knob to choose target function. Press SELECT once to enter the target function, press PARAM to quit to upper layer.

1. OUPUT MODE



While you enter to OUTPUT MODE, you can rotate the SELECT knob to choose the output mode. As you can see the display has 4 parameters: LOW, MID, M-FREQ, HIGH. These are global EQ in the end of signal chain. You can press NR button to highlight LOW, press AMP button to highlight MID, press CAB button to highlight M-FREQ, press EQ button to highlight HIGH. Then rotate the PARAM knob to adjust the related parameters. Press SELECT to save, or press PARAM to quit.

2. PEDAL CALIBRATION



Follow the display guide, it's intuitive to operate.

3. RESET



Global Setting

4. USB SET

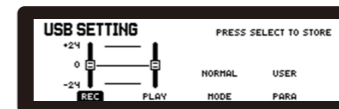

You can press NR button to highlight REC level, press AMP button to highlight PLAY level, press CAB button to highlight MODE, press EQ button to highlight PARA. Then rotate PARAM knob to adjust the related parameters. Press SELECT knob to save, or press PARAM knob to quit.

Warning!! In order to offer you the best dynamic range of USB Streaming, Trident doesn't adjust the PC's audio system playback. So while you use TRIDENT as the USB audio interface, remember to adjust the PC's playback volume from the "minimum" to the desired volume. It can protect your ears.

5. PARA FOLLOW

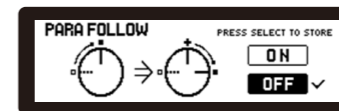

Engage PARA FOLLOW function to remember your parameter tweaking habits.

6. MIDI

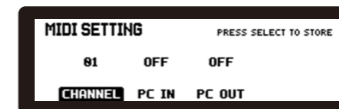

MIDI CHANNEL: OMNI,1~16

PC IN (Program Change In): Engage / Disengage TRIDENT to accept MIDI PC commend.

PC OUT (Program Change Out): Engage / Disengage TRIDENT to send MIDI PC commend.

Trident™ Editor

You can download the Trident™ editor from the product page. Here, you can see the interface for adjusting parameters, dragging block order, save patches, load patches, export patches, load IRs, set up USB routing on Trident™ editor.

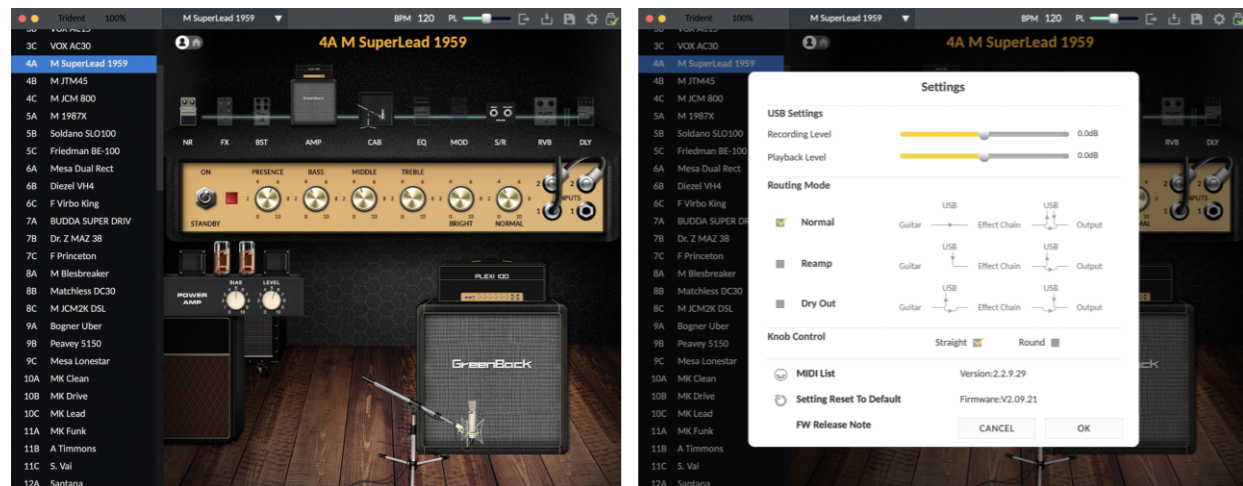

For more details, you can watch TRIDENT's tutorial videos on the NUXEFX YouTube channel.

Block Reference

NR:

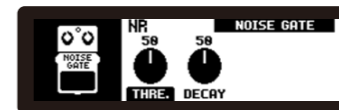

FX:

COMP

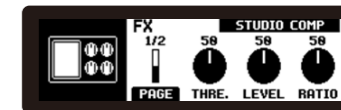
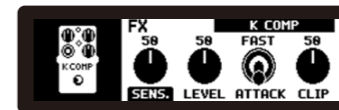
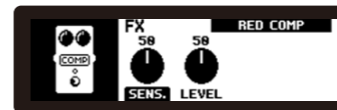

FILTER

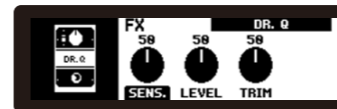

PITCH

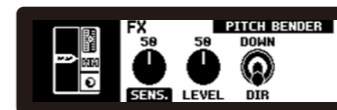

Block Reference

BOOST



AMP

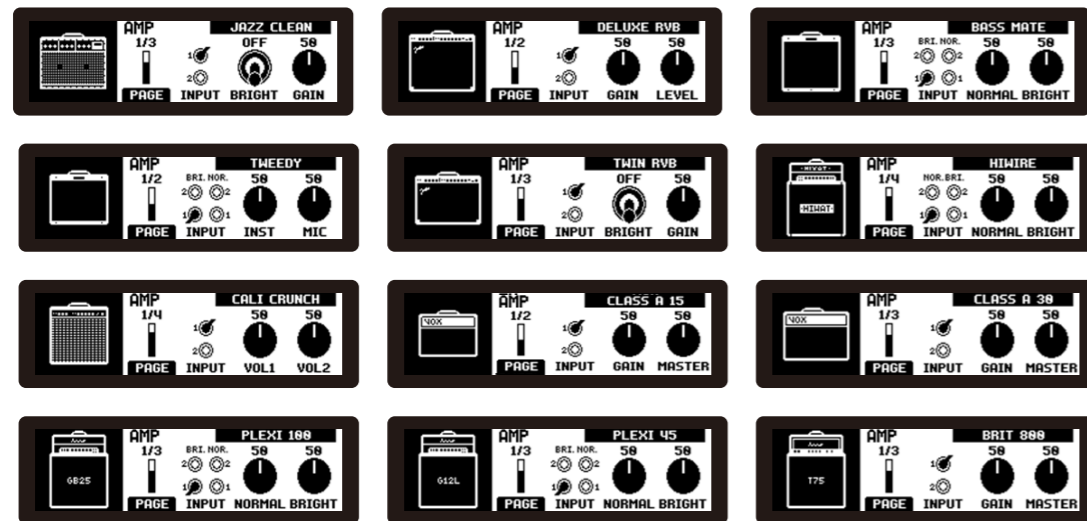

Block Reference

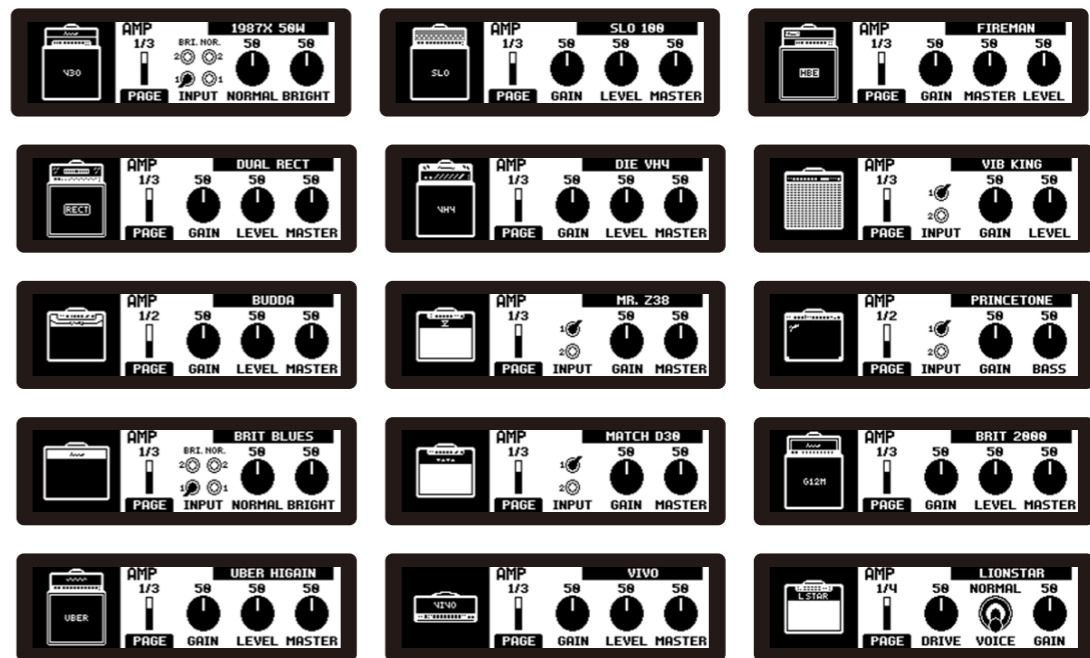

CAB(IR)

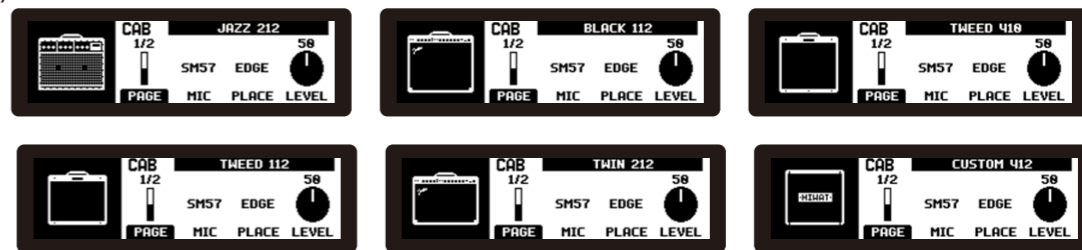

Block Reference

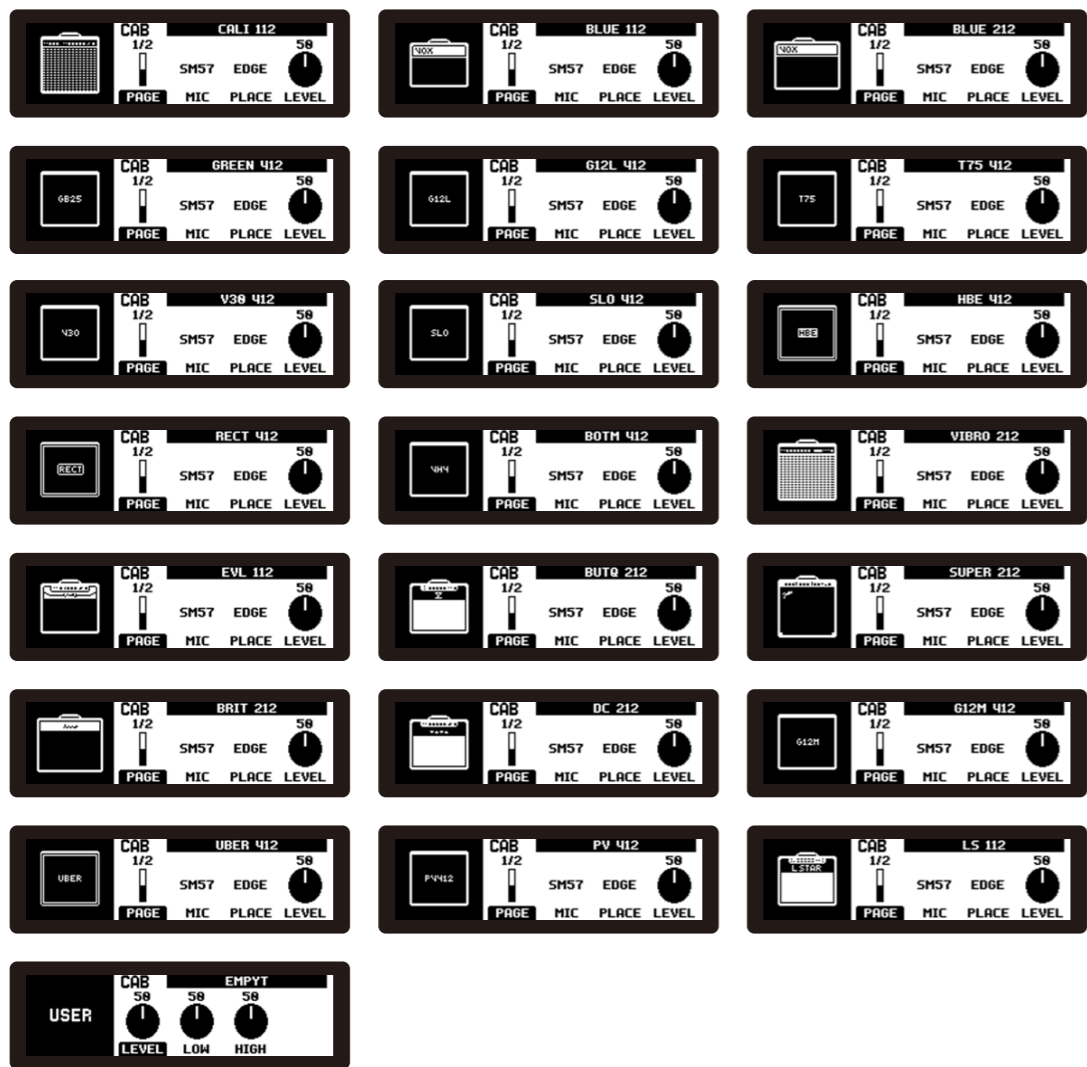

Block Reference

S/R

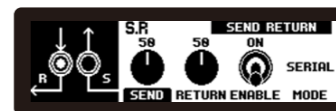

Mode: Serial, Parallel, Branch.

*Branch mode only SENDS the signal out.

EQ



MOD:

CHOR



Block Reference

TREM

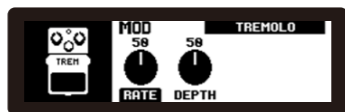

PHAS

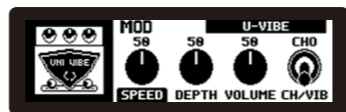
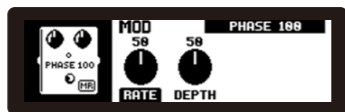
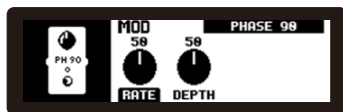

DLY:

BBD



TAPE

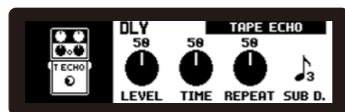

DIGI



Block Reference

RVB:

SPR

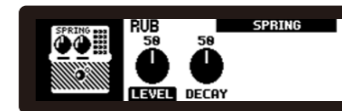

PLA

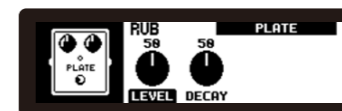

HAL

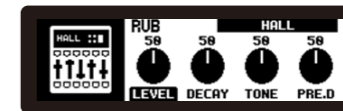
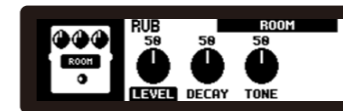

PEDAL:

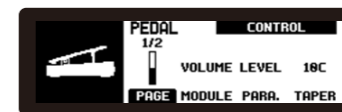

PL:



Specifications

- INPUT Impedance: 1M Ω
- AUX IN Impedance: 10k Ω
- RETURN Impedance: 100k Ω
- OUTPUT 1, OUTPUT 2, SEND Impedance: 1k Ω
- Phone Impedance: 47 Ω
- Dynamic Range: 109 dB
- Sampling Rate: 48kHz / 32 bit
- System Latency: 1 ms
- Power: 9V DC (Negative Tip, included ACD-006A adaptor)
- Current Draw: < 330mA
- Dimensions: 312(L) x 164(W) x 65(H)mm
- Weight: 1.65 kg

*Specifications and features are subject to change without notice.

What's in the box?

NME-5 x 1, Power Adapter x 1, USB Cable x 1, 3.5mm TRS to 5 pin MIDI adaptors x 2, Footswitch Cap x 5, User Manual x 1, Warranty Card.

请注意！重要安全说明。
在连接使用前，阅读以下说明。

警告：为减少火灾或触电的危险，请勿将本产品置于雨中或潮湿的地方。

注意：为避免火灾或触电等危险，请勿擅自拆卸本产品。维修本产品内部部件对于非专业人员来说较为困难，若有损坏请交给专业维修人员处理。

注意：本产品已经过测试，证明符合FCC规则第15部分的B级数字设备的限制规定。操作应符合以下两个条件：（1）本产品不会产生有害干扰，且（2）本产品必须接受任何干扰，包括可能会导致非正常操作的干扰。

1. 仅能使用与出厂附带规格相同的电源及电源线。如果您不确定可用的电源类型，请咨询您的经销商或当地的电力公司。
2. 请勿放置在热源附近，如散热器、电热器，或其它产生高热量的设备。
3. 请勿让液体、灰尘及其它物体进入本产品。
4. 打开或取下后盖板可能会产生触电或其它危险，请勿尝试自行维修本产品。如需维修，请联系我司售后热线，或交给专业的维修人员。
5. 当设备遭遇电源线或插头损坏、不明物体进入、进水等情况时，请谨慎使用并主动联系售后维修。
6. 如果长时间不使用本产品，应拔掉电源线。
7. 避免踩踏电源线，避免过度绷紧电源线。
8. 人耳长时间接收高音量声音可能会导致无法挽回的听力损害，请始终保持“安全聆听”。

请遵守所有的指示和注意所有警告并保留这些说明！

产品简介

感谢并祝贺您购买NUX® TRIDENT（纽克斯®三叉戟）复合型单块效果器。2016年NUX® Cerberus（纽克斯®三头犬）发布后不久，我们便开始着手规划一款新的复合型单块效果器。它需要与NUX® Cerberus在设计语言上保持一致且具有极致的音色、简洁的操作、直观的调节反馈以及一款功能强大的编辑软件来提供整体最佳的用户体验。历经六载磨砺，我们相信TRIDENT就是这样一款优异的产品。

*这是一份快速入门手册，旨在让您快速上手使用TRIDENT这款产品。如果您需要了解更为深入的产品信息，请移步至我司中文官方网站、NUX纽克斯哔哩哔哩主页或NUX用户QQ群。

TRIDENT是一款搭载了我司标志性的TS/AC-4K音箱建模技术（白盒物理建模算法）的复合型单块效果器。TS/AC-4K音箱建模技术的复杂度相较于上一代（TS/AC-2K）提升了一倍，这使得我们设计了一个全新的具有两个高性能DSP的硬件平台，一个用于处理效果音色，另一个处理音箱建模算法。此外，TRIDENT使用了优质的A/D、D/A转换芯片和模拟电路来降低噪声水平，进而提升音色清晰度。

世界一流的音箱建模技术，真实的不像话！高低阻抗输入、四输入接口-串接跳线、音色切换拨档开关，原型音箱上有的TRIDENT统统都有且全部都真！

TRIDENT的旋钮、拨档开关和踩钉布局跟单块效果器一样直观，您可以自由地激活或关闭效果模块；TRIDENT的显示屏虽小却大有洞天，配合PARAM旋钮及SELECT旋钮可以迅速进行调参。

TRIDENT采用一体成型压铸铝制外壳，就是硬核！接口丰富可满足各种使用场景-SENT/RETURN组合接口串入外部效果器，两个XLR平衡输出直入调音台，PHONES接口用作监听，EXP.PEDAL接口外接表情踏板，MASTER VOL旋钮调整整体音量，还有MIDI输入输出接口。此外，TRIDENT还有配套免费编辑软件，以及不定期固件更新。

再次祝贺您购买NUX® TRIDENT（纽克斯®三叉戟）复合型单块效果器，请记得多多访问产品页面获取产品固件、固件更新介绍以及编辑软件。

控制面板

LEVEL 旋钮^⑤
 TIME 旋钮
 REPEAT 旋钮
 DLY types 拨挡开关^⑥

LEVEL 旋钮^⑤
 DECAY 旋钮
 RVB 拨挡开关^⑧

DLY&RVB Routing 拨挡开关^⑦

RATE 旋钮
 LEVEL 旋钮^①
 MOD 拨挡开关^③

SENSE 旋钮
 LEVEL 旋钮^②
 FX 拨挡开关^④

DEPTH 旋钮



SELECT 旋钮
 PARAM 旋钮
 显示屏

GAIN 旋钮
 LEVEL 旋钮
 BASS 旋钮
 MIDDLE 旋钮
 TREBLE 旋钮
 PRESENCE 旋钮
 NR 按键
 AMP 按键
 CAB 按键
 EQ 按键

UP 踩钉
 REVERB 踩钉
 DELAY 踩钉
 MOD 踩钉
 FX 踩钉
 DOWN 踩钉
 A 踩钉
 B 踩钉
 C 踩钉
 BOOST 踩钉

背板接口

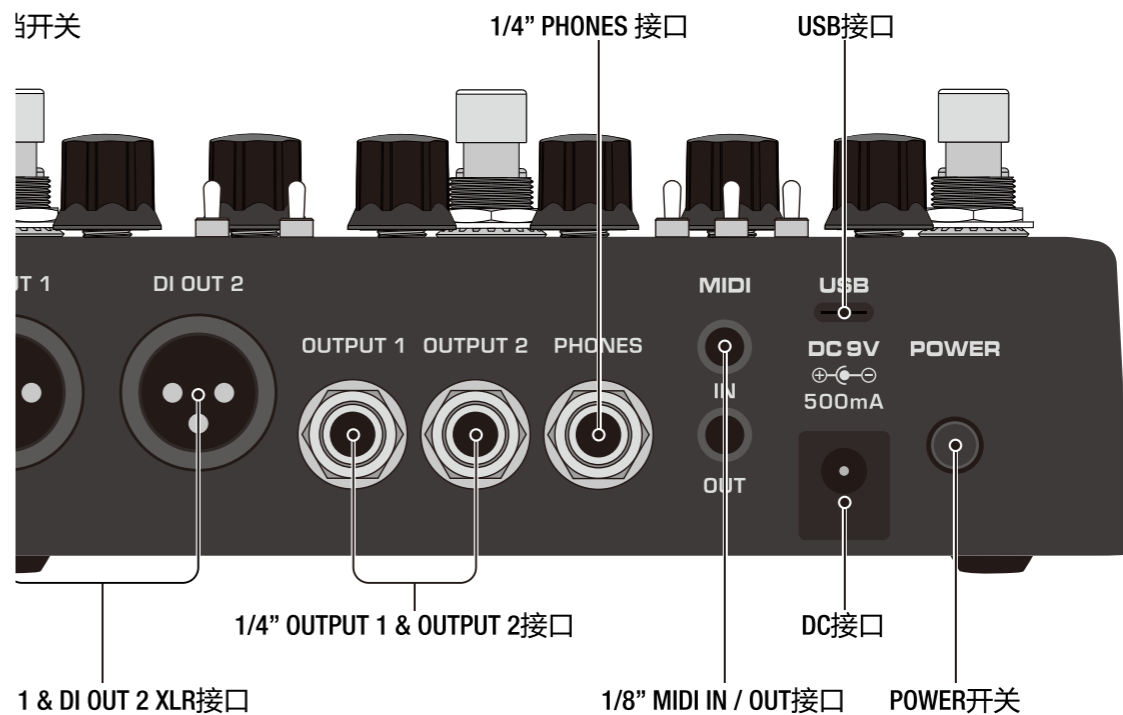
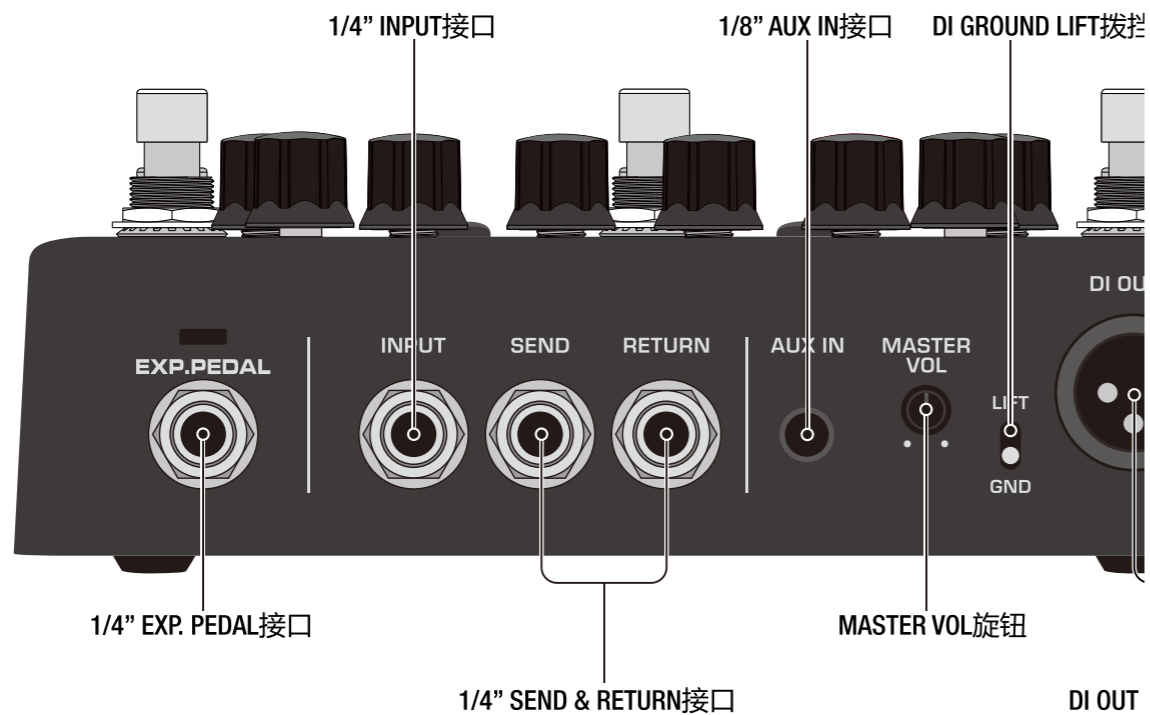

产品特点

- 一体成型压铸铝质外壳。
- 世界一流的音箱建模技术，功能齐全（如四输入接口-串接跳线）。
- TS/AC-4K白盒建模算法的音箱模型及EFX模型为您带来真实手感反馈。
- 10个独立可自由移动的效果模块。
- 1024采样点的IR，带32个第三方IR存储位。
- FX模块、MOD模块、REVERB模块以及DELAY模块带实体调节旋钮。
- 音箱模型实体调节旋钮。
- 96个预设。
- 60秒乐句循环。
- 参数跟随功能。
- USB音频接口，固件更新，免费配套编辑软件。
- 丰富的输入输出接口。

准备工作

1. 取出TRIDENT、准备好音箱（监听音箱或FRFR音箱）并确保二者均处于关机状态，然后将音箱的音量调至最低。将吉他连接至INPUT接口，根据实际情况将音箱连接至OUTPUT 1和OUTPUT 2或DI OUT 1和DI OUT 2。
2. 使用附赠的NUX ACD-006A电源适配器为TRIDENT供电，并按下POWER按键（电源键）开机，将与TRIDENT相连的音箱接上电源并开机。
3. 调节音箱的输出音量旋钮至12点钟位置（50%音量或略低于50%音量）。



警告：为了提供最大的动态范围，TRIDENT用作USB音频接口时不会削弱您电脑的系统音量。因此，在您使用TRIDENT连接电脑录音时，请务必将电脑系统音量调至最低然后逐步调整至合适音量。保护听力，尽情玩乐！

4. 设置OUTPUT MODE（输出模式）：同时按下SELECT旋钮以和PARAM旋钮进入GLOBAL SETTING（系统菜单）设置界面，然后按一次SELECT旋钮进入OUTPUT MODE（输出模式）设置菜单。向左或向右缓慢转动SELECT旋钮选择所需输出模式，然后按SELECT旋钮来保存设置。

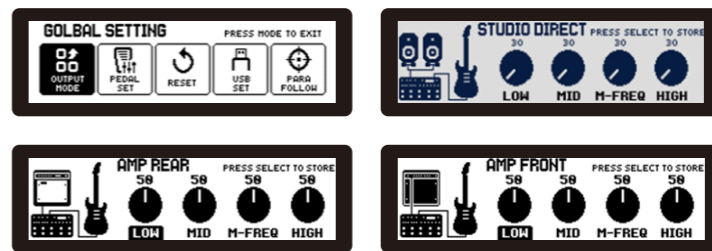

*输出模式为STUDIO DIRECT时，CAB模块默认开启；其他输出模式默认关闭CAB模块。

*输出模式为STUDIO DIRECT时，TRIDENT输出带箱体模拟音色的LINE Level信号；输出模式为AMP FRONT时，TRIDENT输出不带箱体模拟音色的INSTRUMENT Level信号；输出模式为AMP REAR时，TRIDENT输出不带箱体模拟音色的LINE Level信号。

基础操作及开始演奏 - TRIDENT开机后默认进入预设模式



1. 踩（按）UP踩钉或DOWN踩钉上下切换预设组别，预设组别数字（01-32）会开始闪烁，此时再踩（按）踩钉A，踩钉B，踩钉C中的任意一个选定所需预设。例：切换至预设组07后，再踩（按）一次踩钉B，即可选定07-B这个预设。
2. 预设模式下，您还可以转动SELECT旋钮来选择预设。
3. TRIDENT内置了32组共计96个出厂预设（32 x 3）以及32组共计96个用户预设（32 x 3）。预设模式下，您可以通过短按SELECT旋钮来调用出厂预设，此时再短按SELECT旋钮回到用户预设。TRIDENT的出厂预设均由专业乐手制作，可以给您提供良好的借鉴。
4. FX模块、BOOST模块，DELAY模块以及REVERB模块可以通过对应的踩钉来激活或者关闭。
5. 预设模式下，DELAY模块有“智能打点设速”（Smart Tap Tempo）功能，您还可以在DELAY（DLY）模块的设置菜单中调整细分时值（Sub-division）。
*智能打点设速（Smart Tap Tempo）专利处于审核阶段。
短按DELAY踩钉可以激活或者关闭DELAY模块，连续踩（按）DELAY踩钉可以“打点设速”（Tap Tempo）。
6. 预设模式下，按NR、AMP、CAB、EQ按键可以激活或者关闭相应模块。

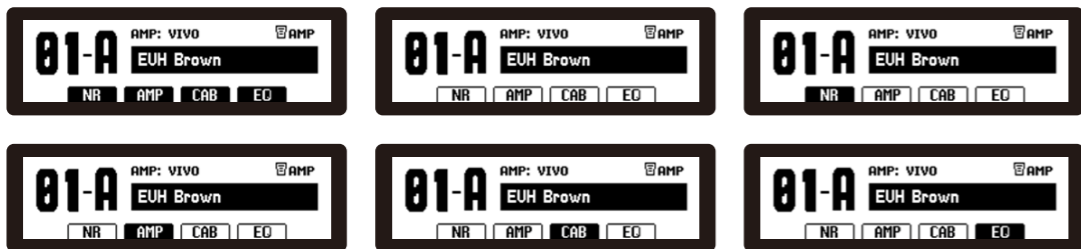

7. 调整效果模块对应的旋钮来调整音色，根据您的需要激活或关闭特定效果模块。

*如需对音色进行细致调节，可短按PARAM旋钮进入编辑模式。编辑模式下，转动PARAM旋钮可以选定一个效果模块（被选定的模块图标会稍微高于其他模块的图标），此时再短按PARAM旋钮即可进入该模块调整菜单。模块编辑菜单下，单个页面最多可以有四个可调项目，您可以通过按NR按键/AMP按键/CAB按键/EQ按键来选定调节项目。

编辑模式进行音色细致调节

1. 短按PARAM旋钮进入编辑模式，TRIDENT屏幕会显示当前预设的基本状态，包括各个效果模块的状态以及相对位置（信号链）。



2. 编辑模式下，在未进入效果模块编辑菜单前，您可以转动SELECT旋钮或使用UP/DOWN踩钉以及踩钉A/踩钉B/踩钉C选择目标预设来进行音色细致调节。
3. 短踩（按）对应的效果模块踩钉（BOOST踩钉/FX踩钉/MOD踩钉/DELAY踩钉/REVERB踩钉）或效果模块按键（NR按键/AMP按键/CAB按键/EQ按键）可以激活或关闭与之对应的效果模块，快速短踩（按）对应的效果模块踩钉两次或连接效果模块按键两次，可以进入与之对应的效果模块编辑菜单。
4. 编辑模式下，转动PARAM旋钮选定目标效果模块，然后按住PARAM旋钮2秒钟，目标效果模块图标会开始闪烁，此时您可以再次转动PARAM旋钮来调整目标效果模块在信号链中的位置，最后再次短按PARAM旋钮进行确认。
5. DELAY（DLY）和REVERB（RVB）模块的顺序和连接方式由对应的三段拨档开关控制，DELAY模块和REVERB模块的组合模块也可以使用PARAM旋钮来进行位置调整。
6. 选定所要调节的模块后，短按PARAM旋钮或快速短踩（按）对应的效果模块踩钉两次或连接效果模块按键两次，可进入模块编辑菜单。

7. 模块编辑菜单下，单个页面最多可以有四个可调项目，您可以通过短按NR按键/AMP按键/CAB按键/EQ按键来选定或切换调节项目并通过转动PARAM旋钮来调整选定项目的参数（选定项目会以黑底白字的方式显示）。调整完毕后短按PARAM旋钮一次退出当前效果模块编辑，此时，您可以继续编辑下一个效果模块。

*模块编辑菜单下，您也可以使用对应的旋钮来直接调整相应的参数。

8. 即便是在模块编辑菜单下，快速短踩（按）对应的效果模块踩钉两次或连按效果模块按键两次即可快速切换模块编辑菜单。

*EQ模块编辑菜单下，因NR按键/AMP按键/CAB按键/EQ按键被用作可调项目切换按键，故而无法快速切换至NR模块/AMP模块/CAB模块编辑菜单。

乐句循环功能

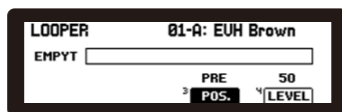

1. 踩（按）住FX踩钉2秒钟即可进入乐句循环菜单，此时FX踩钉变成REC/DUB（录音/叠加）踩钉；MOD踩钉变成PLAY/STOP（播放/停止）踩钉；DELAY踩钉变成UNDO/REDO（撤销/重做）踩钉；REVERB踩钉变成CLEAR（清除）踩钉。
2. 短按CAB按键可激活循环乐句的位置（POS.）选择功能，转动PARAM旋钮可以选择PRE（前置）或者POST（后置）。当选择PRE时，乐句循环功能录制的是干音信号，循环乐句播放时，您可以调节其他效果模块的参数来改变循环乐句的音色；当选择POST时，乐句循环功能录制的是湿音信号，循环乐句播放时，您无法对其音色进行调整。
3. 短按EQ按键可激活循环乐句音量控制功能，转动PARAM旋钮可调整循环乐句播放的音量。
4. 未开始录音前，乐句循环功能状态为EMPTY（空），此时您可以短踩（按）REC/DUB（录音/叠加）踩钉进行录音。录制过程中，您可以根据循环乐句进度条估算剩余录音时间。

REC/DUB踩钉



5. 短踩（按）PLAY/STOP（播放/停止）踩钉可立即停止录音并开始播放乐句。再次短踩（按）PLAY/STOP（播放/停止）踩钉，可停止播放乐句。

PLAY/STOP踩钉

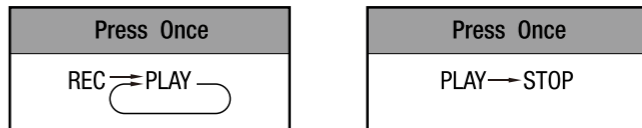

6. 录制好第一层循环乐句后，您可以短踩（按）REC/DUB（录音/叠加）踩钉进行叠加录音，叠加录音完成后短踩（按）PLAY/STOP（播放/停止）踩钉即可开始播放叠加后的录音，如果您对最近一次的叠加录音不满意，可短踩（按）UNDO/REDO（撤销/重做）踩钉撤销，撤销后可再次短踩（按）UNDO/REDO（撤销/重做）踩钉重做。

UNDO/REDO踩钉

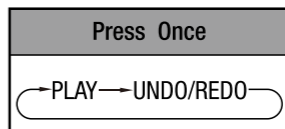

7. 短踩（按）CLEAR（清除）踩钉可删除循环乐句。
8. 踩（按）住CLEAR（清除）踩钉2秒钟即可退出乐句循环菜单（循环乐句可以继续播放），再次踩（按）住FX踩钉2秒钟，可再次回到乐句循环菜单。TRIDENT断电或关机后，录制好的循环乐句会被自动清除。

CLEAR踩钉

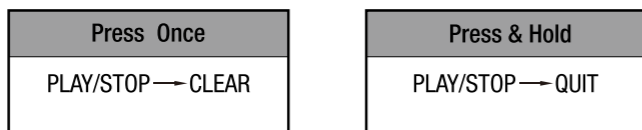

9. TRIDENT的乐句循环功能最长录音时间为60秒钟。

LOOPER MODE踩钉操作逻辑

REC/DUB踩钉

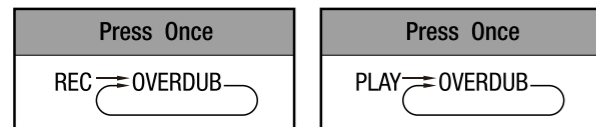

PLAY/STOP踩钉

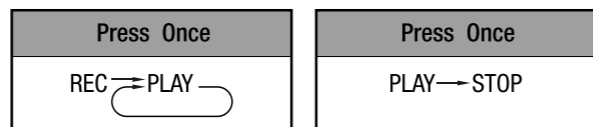

UNDO/REDO踩钉

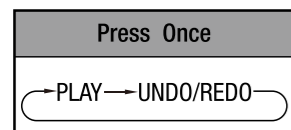

CLEAR踩钉

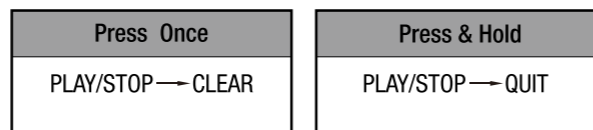

调音器功能



1. 踩（按）住BOOST踩钉2秒钟即可激活调音器功能并进入调音模式。
2. 调音模式下，您可以转动PARAM旋钮来调整A4值（调整范围：430-450Hz）。
3. 调音模式下，短按EQ按键可选择是否静音。
4. 调音完成，可短踩（按）任意踩钉退出调音模式。

SELECT旋钮，PARAM旋钮，显示屏



预设模式下，同时按下SELECT旋钮和PARAM旋钮可进入全局设置（Global Setting）菜单，短按PARAM旋钮可以退出菜单。



进入全局设置菜单后，转动SELECT旋钮可以选择调整设置项；选择好设置项目后短按SELECT旋钮可以进入该项目设置页面。项目调整完毕后，短按PARAM旋钮即可回到全局设置菜单。

1. 输出模式（OUTPUT MODE）设置页面

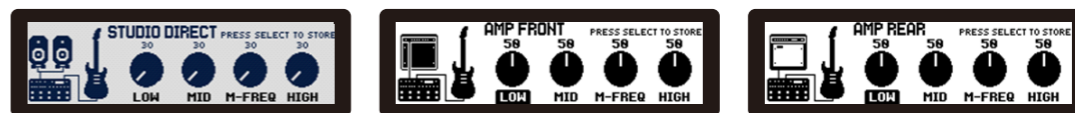

进入输出模式设置页面后，转动SELECT旋钮可选择输出模式。每个输出模式均有四个可调参数：LOW，MID，M-FREQ，HIGH。这四个参数是位于信号链最后的全局EQ（均衡器），短按NR按键/AMP按键/CAB按键/EQ按键来选定或切换调节项目并通过转动PARAM旋钮来调整选定项目的参数（选定项目会以黑底白字的方式显示）。调整完毕后，短按SELECT旋钮来保存设置，或者短按PARAM旋钮即可回到全局设置菜单。

2. 表情踏板校准页面



进入表情踏板校准页面后，请依据屏幕提示将外置表情踏板校准。

3. 恢复出厂设置页面



如果您需要将您的TRIDENT恢复出厂设置，转动PARAM旋钮选择YES，然后短按SELECT旋钮执行恢复出厂设置操作。放弃恢复出厂设置可直接短按PARAM旋钮回到全局设置菜单。

4. USB设置页面

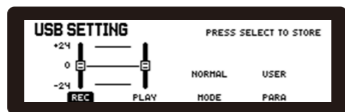

使用TRIDENT连接电脑录音前，您需要进入此页面根据实际情况进行设置，短按NR按键/AMP按键/CAB按键/EQ按键来选定或切换调节项目并通过转动PARAM旋钮来调整选定项目的参数（选定项目会以黑底白字的方式显示）。调整完毕后可短按SELECT旋钮来保存设置，或者短按PARAM旋钮回到全局设置菜单。

5. 参数跟随设置页面

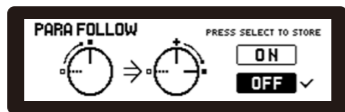

转动PARAM旋钮进行设置，ON代表参数跟随开启；OFF代表参数跟随关闭。

6. MIDI设置页面



短按NR按键/AMP按键/CAB按键来选定或切换调节项目并通过转动PARAM旋钮来调整选定项目的参数（选定项目会以黑底白字的方式显示）。调整完毕后可短按SELECT旋钮来保存设置，或者短按PARAM旋钮回到全局设置菜单。

编辑模式



预设模式下，您可以短按PARAM旋钮进入编辑模式，编辑模式界面如下图所示。

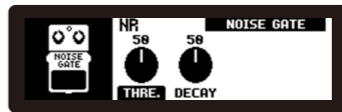

编辑模式下，您可以查看各个效果模块的状态，转动PARAM旋钮可以选定一个效果模块（被选定的模块图标会稍微高于其他模块的图标），此时再短按PARAM旋钮即可进入该模块调整菜单。

如果您想要改变效果模块在信号链中的位置，转动PARAM旋钮选定目标效果模块，然后按住PARAM旋钮2秒钟，目标效果模块图标会开始闪烁，此时您可以再次转动PARAM旋钮来调整目标效果模块在信号链中的位置，最后再次短按PARAM旋钮进行确认。完成调整后，长按SELECT旋钮进行保存。

编辑模式下，短按SELECT旋钮可退出编辑模式回到预设模式。

显示屏下方的旋钮及按键



预设模式下，NR按键/AMP按键/CAB按键/EQ按键可用于开启或者关闭与之对应的效果模块。

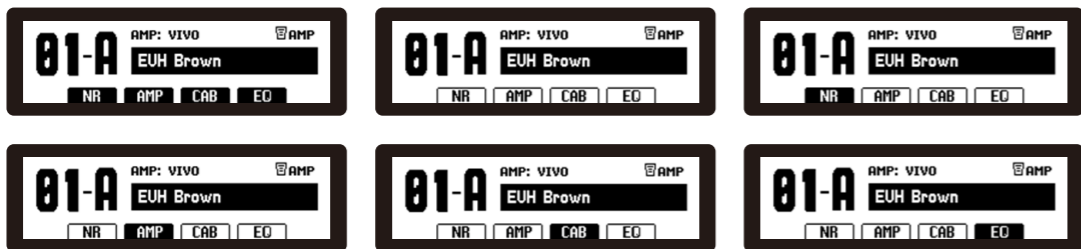

预设模式或编辑模式下，GAIN旋钮，LEVEL旋钮，BASS旋钮，MIDDLE旋钮，TREBLE旋钮，PRESENCE旋钮均可以用于调节AMP模块的参数。

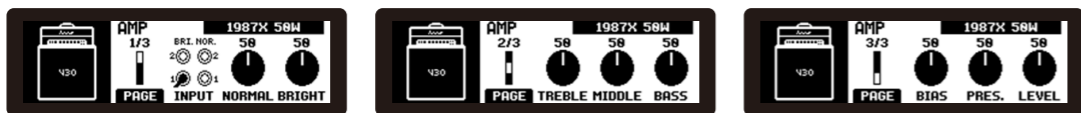

MOD模块 | FX模块的旋钮及拨档开关



预设模式或者编辑模式下，RATE旋钮，DEPTH旋钮，LEVEL旋钮^①用于调节MOD模块下效果原型对应的参数；SENSE旋钮，LEVEL旋钮^②可调节FX模块下效果原型对应的参数。FX拨档开关^④用于切换效果模块下不同的效果类型。

COMP类效果包含如下效果原型：

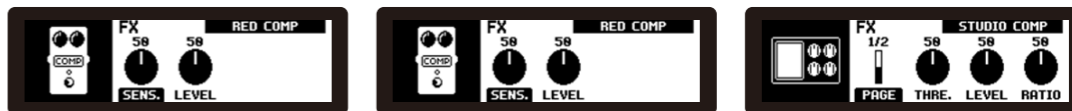

FILT类效果包含如下效果原型：



PITCH类效果包含如下效果原型：



MOD拨档开关^③用于切换效果模块下不同的效果类型。

CHOR类效果包含如下效果原型：

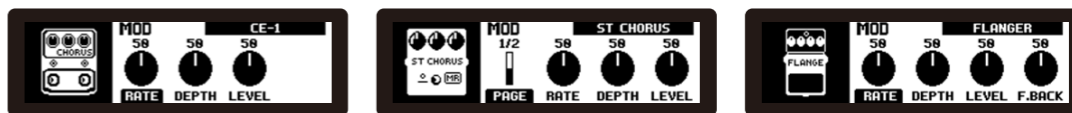

控制面板

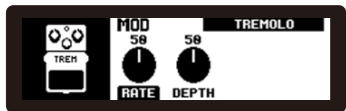
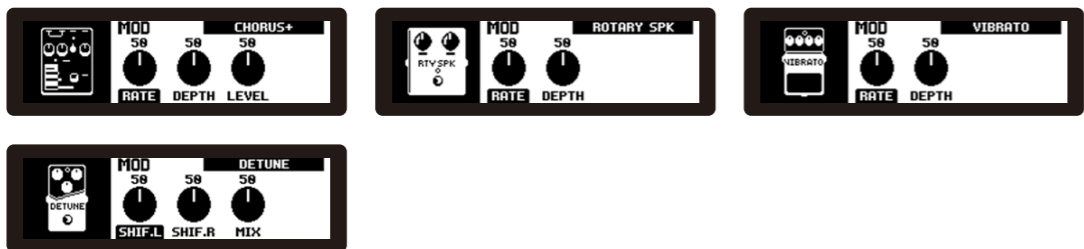

TREM类效果包含如下效果原型：

PHAS类效果包含如下效果原型：

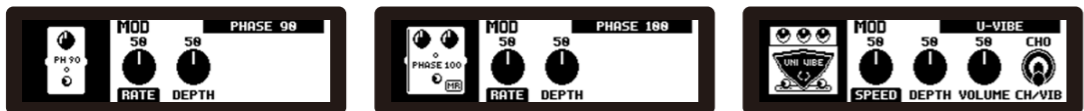

*注意：上述效果原型信息基于V1版本固件。

DELAY (DLY) 模块 | REVERB (RVB) 模块的旋钮及拨档开关



控制面板

预设模式或者编辑模式下，LEVEL旋钮^①，TIME旋钮，REPEAT旋钮可用于调节DLY模块下效果原型对应的参数；LEVEL旋钮^②，DECAY旋钮可调节RVB模块下效果原型对应的参数。

DLY拨档开关^③

用于切换效果原型，如下图所示：



DLY/RVB模块连接方式拨档开关^④

用于切换DLY模块和RVB模块的连接方式。

RVB拨档开关^⑤

用于切换效果原型，原型如下：

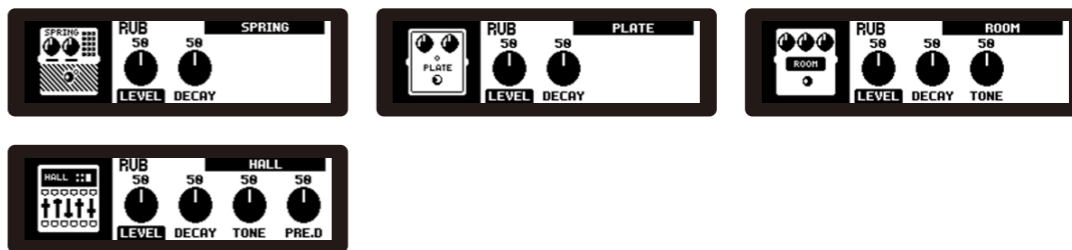

踩钉



TRIDENT共有八个踩钉分别是：UP踩钉，DOWN踩钉，A踩钉，B踩钉，C踩钉，BOOST踩钉，FX踩钉，MOD踩钉，DELAY踩钉以及REVERB踩钉。

预设模式下，UP踩钉和DOWN踩钉用于切换预设组别（01-32），然后踩（按）A踩钉，B踩钉，C踩钉选定预设组中的预设。

预设模式下，BOOST踩钉，FX踩钉，MOD踩钉，DELAY踩钉以及REVERB踩钉用于开启或关闭对应的效果模块。有节奏地连续踩（按）DELAY踩钉，可进行智能打点设速。

编辑模式下，快速踩（按）BOOST踩钉，FX踩钉，MOD踩钉，DELAY踩钉以及REVERB踩钉两次可以进入与之对应的效果模块编辑菜单。

踩（按）住BOOST踩钉2秒钟即可激活调音器功能并进入调音模式，踩（按）任意踩钉可退出调音器模式。



预设模式下，踩（按）住FX踩钉2秒钟即可进入乐句循环菜单，此时FX踩钉变成REC/DUB（录音/叠加）踩钉；MOD踩钉变成PLAY/STOP（播放/停止）踩钉；DELAY踩钉变成UNDO/REDO（撤销/重做）踩钉；REVERB踩钉变成CLEAR（清除）踩钉。

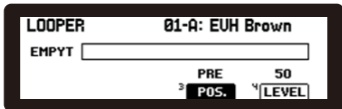

LOOPER MODE 踩钉操作逻辑

REC/DUB踩钉

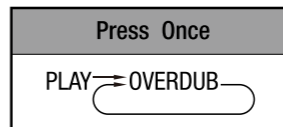
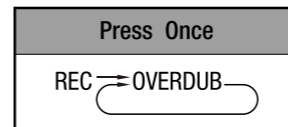

PLAY/STOP踩钉

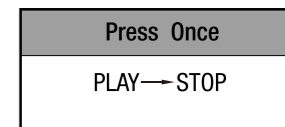
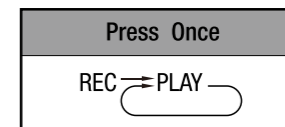

UNDO/REDO踩钉

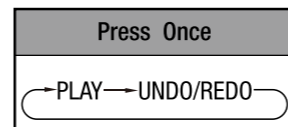

CLEAR踩钉

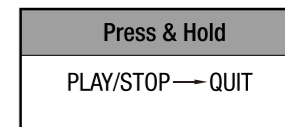
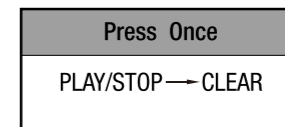

背板接口

电源开关

POWER



用于开启或关闭TRIDENT。

电源接口

DC 9V
⊕ ⊖
500mA



将TRIDENT原装电源适配器插入此接口然后接入市电，使用非原装电源适配器时，请务必确认电源极性！

USB接口

USB



USB-C数据交换接口，请使用品质合格的USB-C数据线连接电脑进行固件更新、录音或使用配套的编辑软件。

• 固件更新简要指南

将TRIDENT与电脑连接好，同时按住UP踩钉和REVERB踩钉，然后按电源键开机，TRIDENT会进入固件升级模式。新固件、固件更新软件及详细固件更新指南请访问NUX中文官网TRIDENT产品页面查询及下载。

• ASIO驱动

Windows用户需要根据电脑所运行的系统版本下载并安装对应的ASIO驱动，否则编辑软件以及USB录音功能可能无法正常工作。

***注意：** TRIDENT连接电脑使用时，为了避免USB冲突，请拔掉其他不必要的USB设备，尤其是USB声卡以及USB MIDI设备。

背板接口

MIDI IN/OUT组合接口

MIDI



IN



OUT

3.5mm TRS MIDI接口，使用附赠的3.5mm TRS转5-PIN线连接外部MIDI设备。

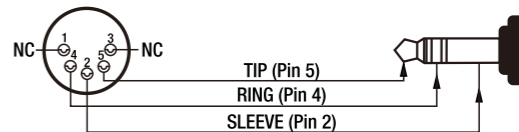

警告： 非辅助音频输出接口，非辅助音频输入接口。切勿将外部音频播放设备或耳机与MIDI IN/OUT组合接口中任意一个连接，否则您的TRIDENT将会被损坏。

PHONES接口

PHONES



6.35mm音频输出接口，可连接耳机进行静音练习。此接口的输出阻抗为47Ω。

OUTPUT 1和OUTPUT 2接口

OUTPUT 1 OUTPUT 2

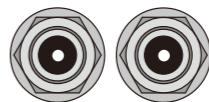

背板接口

6.35mm音频输出接口，仅使用OUTPUT 1接口时，TRIDENT输出单声道非平衡信号，OUTPUT 2输出平衡信号。同时使用OUTPUT 1以及OUTPUT 2时，TRIDENT输出立体声信号。这两个接口的输出阻抗均为1k Ω 。

DI OUT 1和DI OUT 2 XLR接口

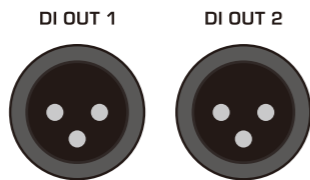

平衡信号输出接口，单独使用DI OUT 1时，TRIDENT输出单声道信号；同时使用两个XLR接口时，TRIDENT输出立体声信号。

LIFT/GND拨档开关



拨动至LIFT档可消除共地噪声。

MASTER VOL旋钮



TRIDENT输出音量调节旋钮。

***注意：**调节音量时，我们建议您从最低位开始然后逐渐调整音量，当旋钮处于12点钟位置时，音量应该已经足够大了！保护听力，至关重要！

背板接口

AUX IN接口



3.5mm辅助音频输入接口，可连接外部音频播放设备输入伴奏。

SEND & RETURN接口



将其他效果器以SEND & RETURN组合接口接入TRIDENT。SEND接口的输入阻抗为1k Ω ；RETURN接口的阻抗为100k Ω 。

*SEND/RETURN有三种模式：Serial（串联），Parallel（并联），Branch（分支）。Branch模式时仅输出信号。

INPUT接口



6.35mm输出接口，将您的吉他连接至此接口。INPUT接口输入阻抗为：1M Ω 。

EXP. PEDAL接口



外部表情踏板接口，使用表情踏板控制效果模块下效果原型的特定参数。

通用连接示例

示例 1

输出模式：SUTIDO DIRECT

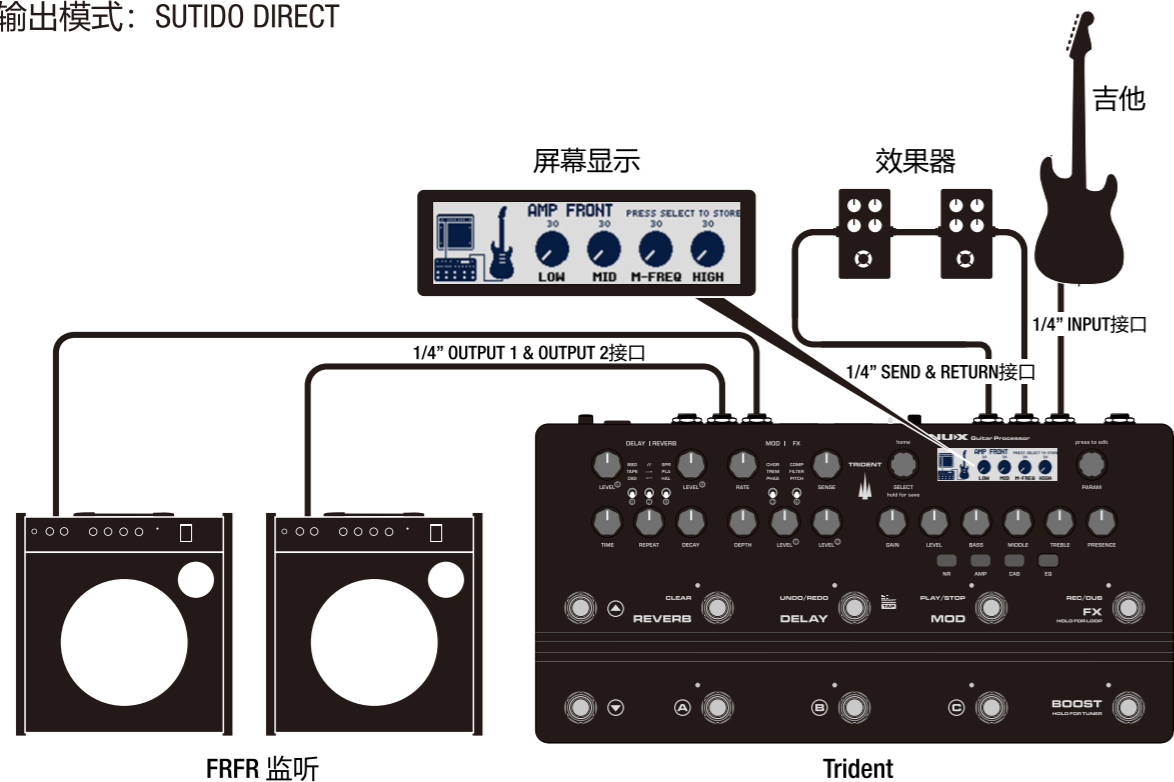

这是使用TRIDENT时获得最佳效果的推荐连接方式之一，除使用两个FRFR音箱（OUTPUT 1和OUTPUT 2）或两个监听喇叭（DI OUT 1 和DI OUT 2），也可仅使用耳机通过PHONES接口连接。

通用连接示例

示例 2

输出模式：AMP REAR（CAB模块默认关闭）

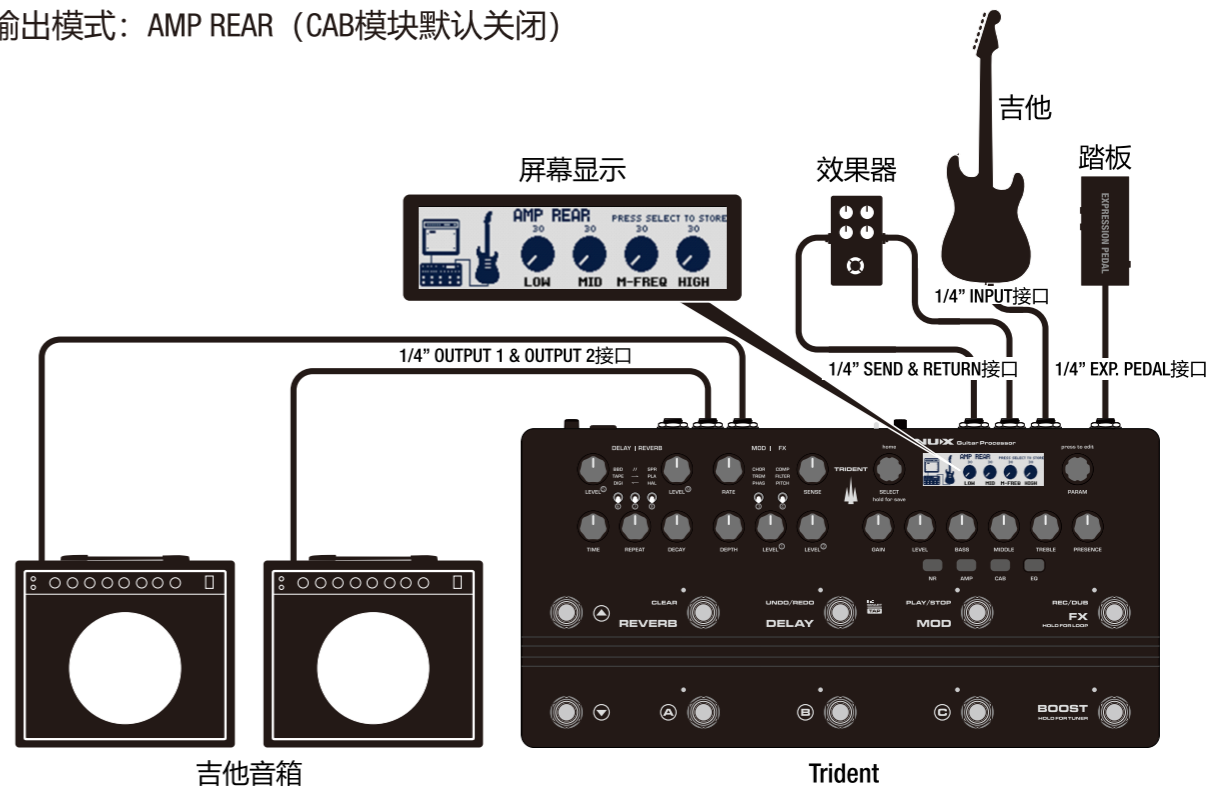

在舞台上演出时，您可以将TRIDENT的OUTPUT 1接口连接至吉他音箱的POWR AMP IN接口或RETURN接口。

通用连接示例

示例 3

输出模式：AMP REAR (CAB模块默认关闭)

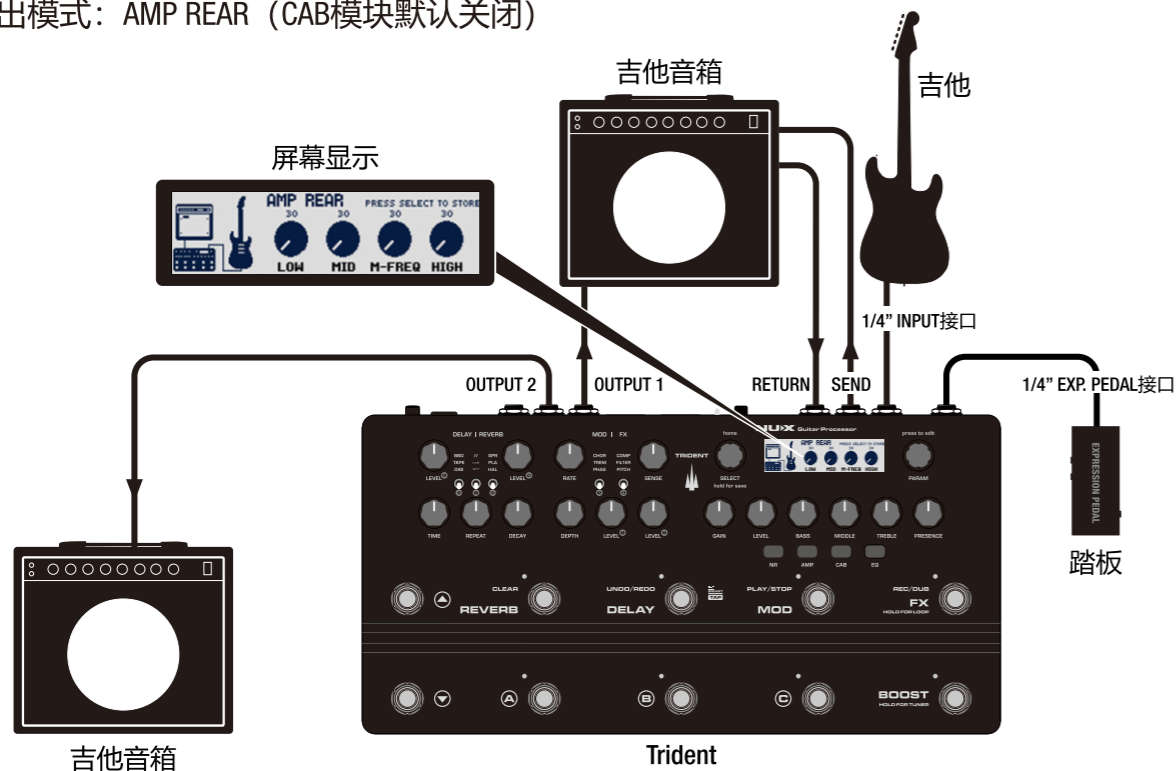

“四线连接法”即使用音箱的前级 (Preamp) + TRIDENT的效果 + 音箱的后级 (Power Amp) + 箱体的喇叭。使用“四线连接法”请务必将预设的AMP模块以及CAB模块关闭。S/R模块为音箱的前级 (Preamp)，您可以根据需要调整S/R模块在信号链中的位置。

连接方式：吉他经INPUT接口 → TRIDENT，TRIDENT的SEND接口 → 音箱INPUT接口，音箱的SEND接口或PREAMP OUTPUT接口 → TRIDENT的RETURN接口，TRIDENT的OUTPUT 1接口 → 音箱的RETRUN接口或POWER AMP IN 接口。

通用连接示例

示例 4

输出模式：AMP REAR (CAB模块默认关闭)

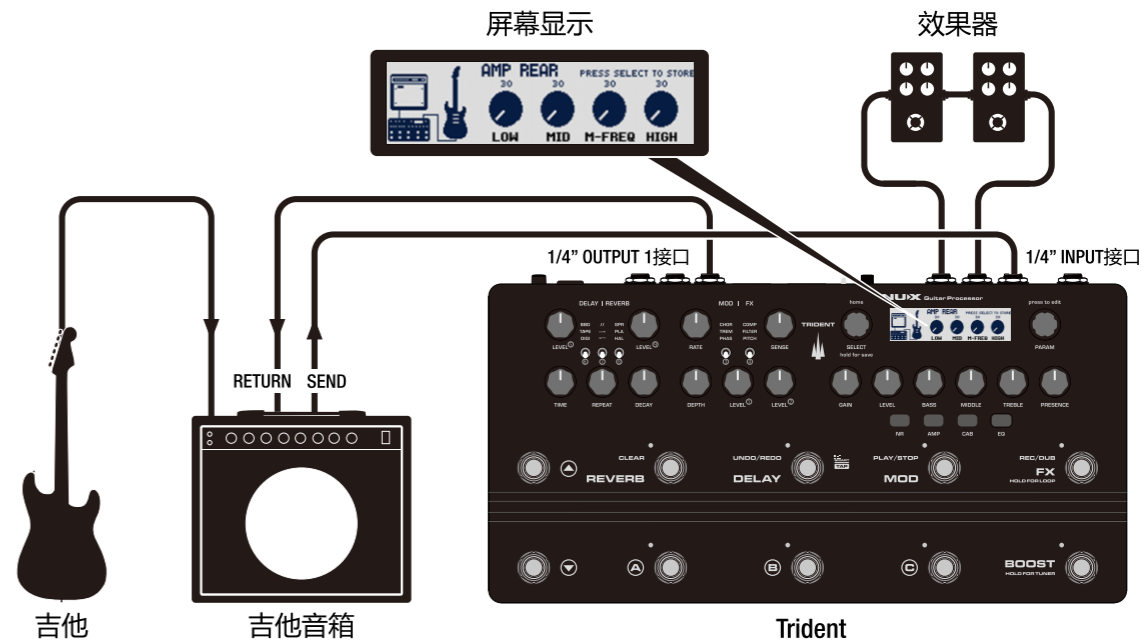

这种连接方式可以让您使用您音箱的前级 (Preamp)，然后把TRIDENT上的效果当成后级效果 (POST Effects) 来用。请务必记得将预设的AMP模块以及CAB模块关闭，然后使用TRIDENT上的EQ模块，MOD模块、DLY模块以及RVB模块等后级效果。

连接方式：音箱的SEND接口 → TRIDENT的INPUT接口，TRIDENT的OUTPUT 1 → 音箱的RETRUN接口。

通用连接示例

示例 5

输出模式：AMP FRONT

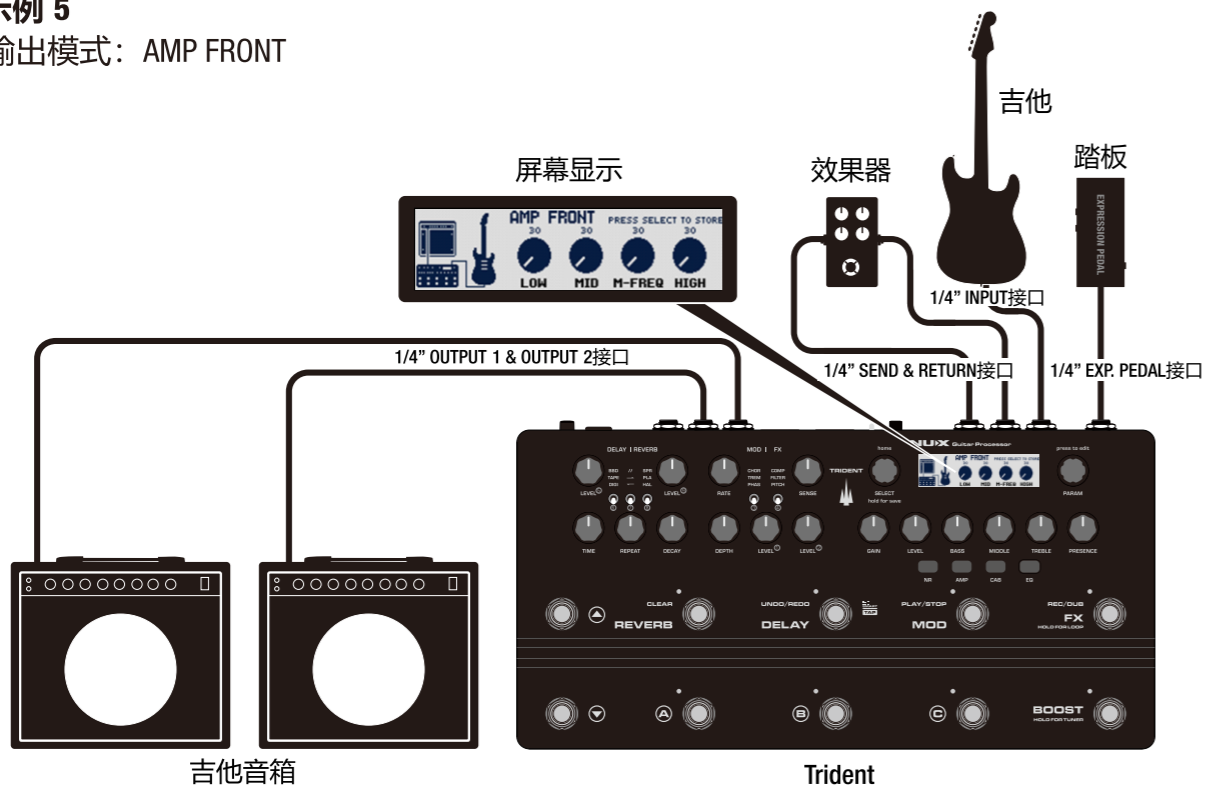

这是TRIDENT最为简单的连接方式，也是我们最不推荐的连接方式。如果实在没有其他选择，一定要用这种连接方式的话，我们建议您在开始的时候，将TRIDENT所有效果模块关闭并将音箱上的均衡器尽量调平，然后再尝试使用TRIDENT上的预设。

连接方式：TRIDENT进音箱。

TRIDENT编辑软件

您可以访问NUX中文官网TRIDENT产品页面下载TRIDENT编辑软件，使用编辑软件可以更直观地调整效果参数，移动效果模块位置，保存预设，导入或导出预设以及调整USB录音设置等。您可以访问我司微信公众号或哔哩哔哩频道获取更多关于TRIDENT使用的介绍或演示视频。

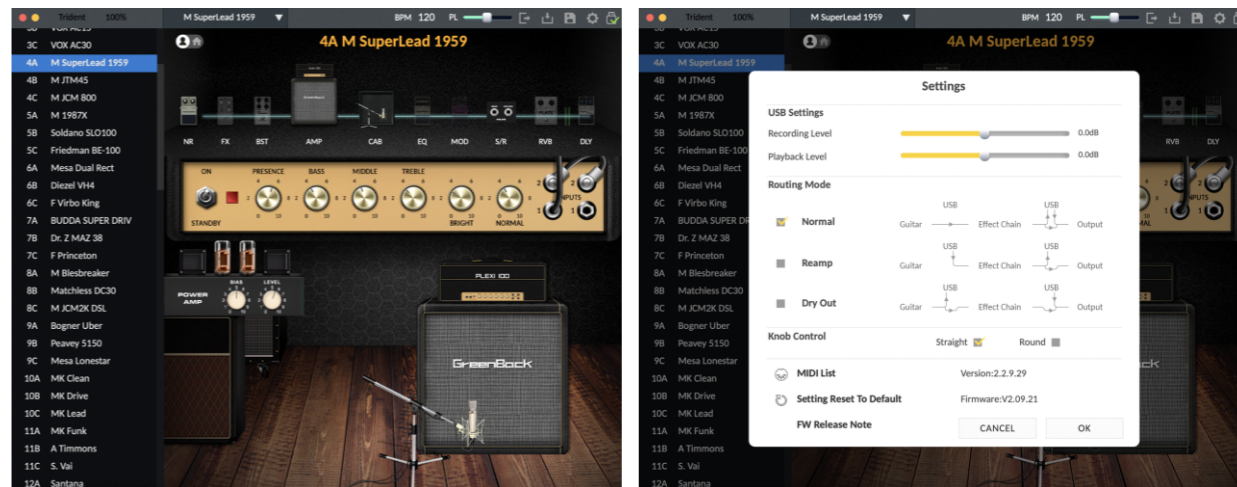

效果模块及效果原型列表

NR:



FX:

COMP

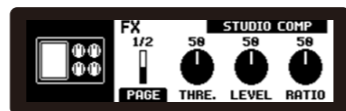
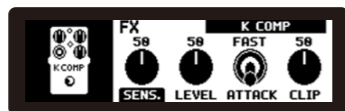
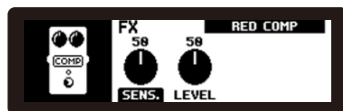

FILTER

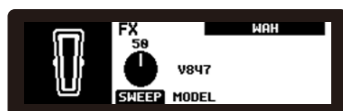
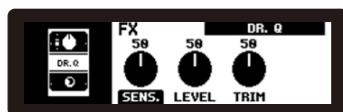

PITCH

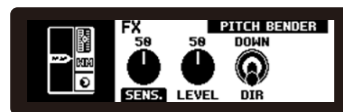

效果模块及效果原型列表

BOOST

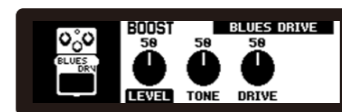

AMP

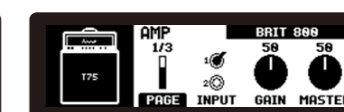
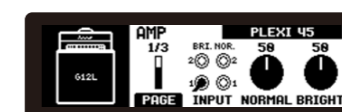
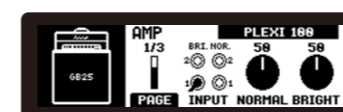
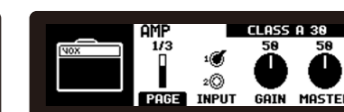
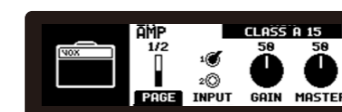
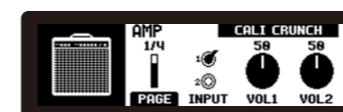
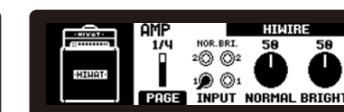
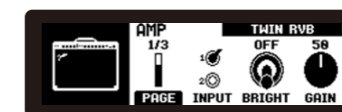
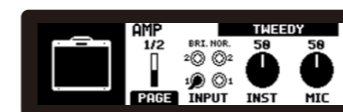
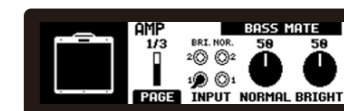
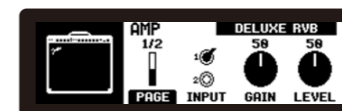
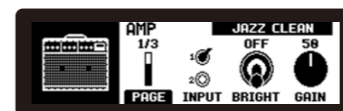

效果模块及效果原型列表

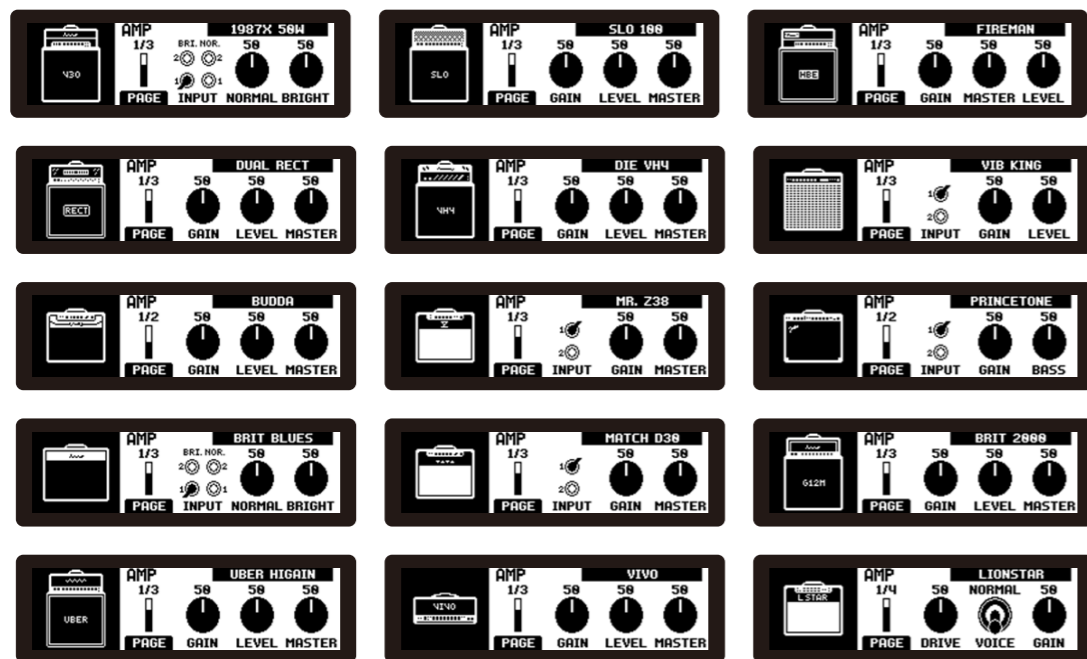

CAB(IR)

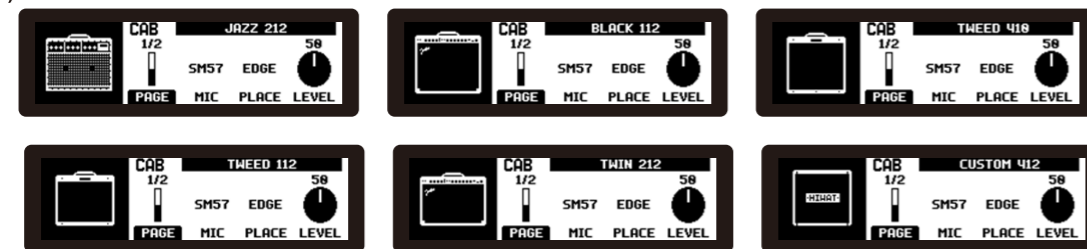

效果模块及效果原型列表

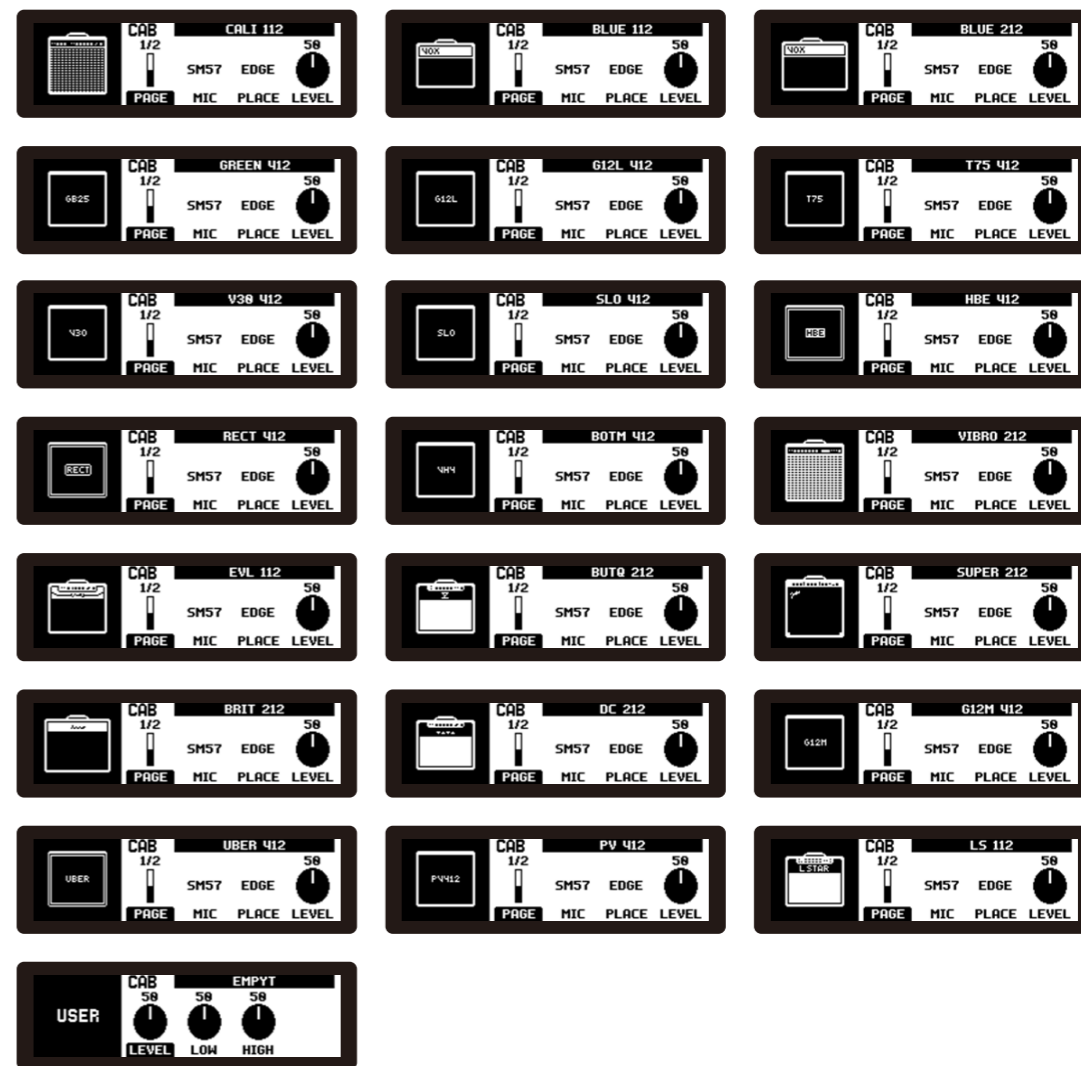

效果模块及效果原型列表

S/R

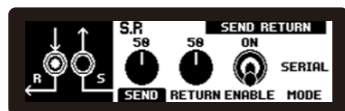

模式：串行、并行、分支。

*分支模式仅发送信号。

EQ



MOD:

CHOR

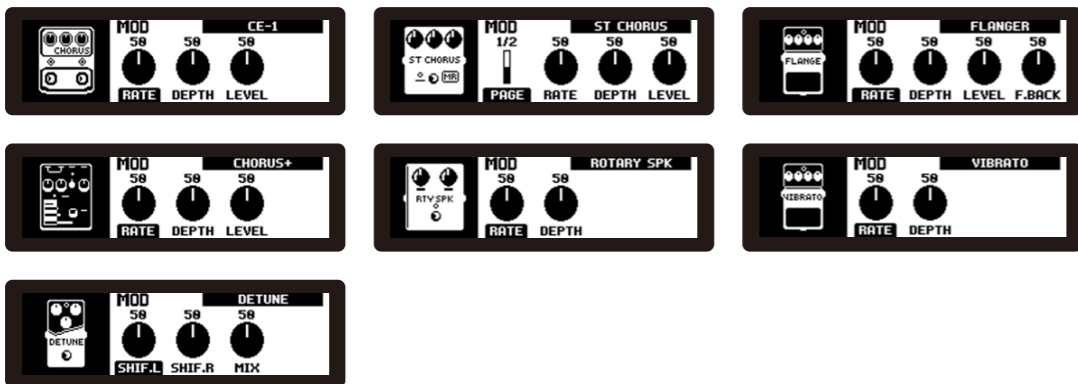

效果模块及效果原型列表

TREM

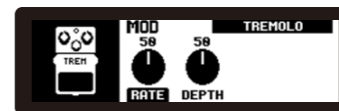

PHAS

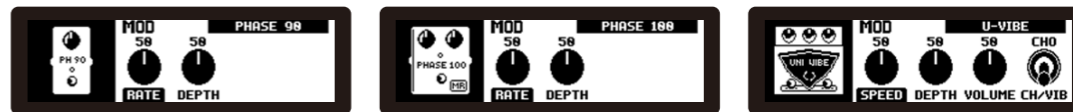

DLY:

BBD



TAPE



DIGI



效果模块及效果原型列表

RVB:

SPR



PLA

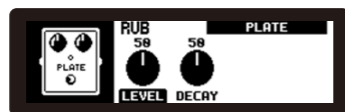

HAL



PEDAL:

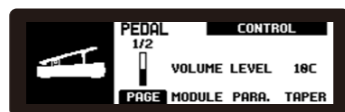

PL:



技术规格

- INPUT接口阻抗: 1M Ω
- AUX IN接口阻抗: 10k Ω
- RETURN接口阻抗: 100k Ω
- OUTPUT 1接口, OUTPUT 2接口, SEND接口阻抗: 1k Ω
- PHONES接口阻抗: 47 Ω
- 动态范围: 109dB
- 采样率: 48kHz / 32bit
- 系统延迟: 1ms
- 电源: 9V DC (外正内负, 配NUX ACD-006A 电源适配器)
- 需求电流: < 330mA
- 体积: 312 (L) x 164 (W) x 65 (H) mm
- 重量: 1.65 kg

*技术规格如有变更恕不另行通知。

随机附件: 电源适配器, USB数据线, 3.5mmTRS转5PIN连接线, 踩钉帽, 使用手册, 保修卡。

有关产品中所含有害物质的说明

为了控制和减少电器电子产品废弃后对环境造成的污染，本资料就本公司产品中所含的特定有害物质及其安全性予以说明。

本资料适用于2016年7月1号以后本公司所制造的产品。

环保使用期限



此标志适用于在中国国内销售的电子信息产品，表示环保使用期限的年数。所谓环保使用期限是指在制造日起的规定期限内，产品中所含的有害物质不致引起环境污染，不会对人体、财产造成严重的不良影响。环保使用期限仅在遵照产品使用说明，正确使用产品的条件下才有效。不当的使用，将会导致有害物质泄漏的危险。

产品中有害物质的名称及含量

部件名称		有害物质					
		铅 (Pb)	汞 (Hg)	镉 (Cd)	六价铬 (Cr(VI))	多溴联苯 (PBB)	多溴二苯醚 (PBDE)
主体	塑胶件	○	○	○	○	○	○
	五金件	×	○	○	○	○	○
	硅胶件	○	○	○	○	○	○
	内置电路板	×	○	○	○	○	○
附件	*交流电源适配器、线缆	×	○	○	○	○	○

*表示某些产品可能不含有这些项目，上表当中的信息仅在产品含有这些项目时适用。

本表格依据SJ/T 11364的规定编制。

○:表示该有害物质在该部件所有均质材料中的含量均在GB/T 26572规定的限量要求以下。

×:表示该有害物质至少在该部件的某一均质材料中的含量超出GB/T 26572规定的限量要求，因根据现有的技术水平，还没有什么物质能够代替它。

保护环境

如果需要废弃本产品，请遵循本地相关指引，请勿随意丢弃或作为生活垃圾处理，以避免对环境造成污染。

质量承诺

亲爱的 **NUX** 用户：

在您使用 **NUX** 产品时，请仔细阅读产品说明书，当您有疑问和困难时，请拨打售后服务热线：

400-990-9866

- 一周内出现质量问题可退货退款
- 一月内出现质量问题可调换
- 一年内出现质量问题可免费维修
- 终身享有咨询和维修服务

[请向销售商索取正规发票并予以保存]

换修政策

一、包换政策：

- 1、消费者通过正规授权渠道购买的产品，自购机之日起1个月之内，在正常使用情况下出现非人为的产品性能故障、且产品外观及包装保持完好，可向所购机的经销商换机。
- 2、消费者在换机时应出示由经销商开出的购机凭证，否则经销商可以不予更换。

二、保修政策：

- 1、消费者通过正规授权渠道购买的产品(以发票所示销售方为准)，自购买之日起1年内，若出现非人为损坏的性能故障，可享受免费维修服务。
- 2、对于超过1年或人为及不可抗力因素造成损坏的产品，我司可提供有偿维修服务。

*本售后政策仅适用于中国大陆地区，其它国家及地区以当地售后政策及法律法规为准。

售后服务地址

广东省珠海市高新区唐家湾镇科技九路10号
珠海市蔚科科技开发有限公司 售后服务部
邮编:519085

制造商: 深圳市蔚科电子科技有限公司
制造商地址: 深圳市南山区蛇口兴华路6号南海意库1号楼507
电话: 0755- 2686 9866
网址: cn.nuxefx.com

生产商: 珠海市蔚科科技开发有限公司
生产商地址: 珠海市高新区唐家湾镇科技九路10号
电话: 0756-3689866

合格证 Certificate

检验员
Inspector

名称
Name 复合型单块效果器

型号
Type NME-5

生产日期
Date

本产品经检验合格
This product is inspected and approved.

执行标准: Q/WKDZ 001-2020
Product is certificated with Q/WKDZ 001-2020